

## SEC-Grooving Tool Holders GND series

**GND** Series

Rev. 17



**Stable Machining  
Through Outstanding  
Chip Control and Chatter  
Resistance**



Groove depths up to 32mm supported  
**GNDXL type + Dedicated  
1-cornered Insert**



- High precision machining with a cutting width tolerance of  $\pm 0.03\text{mm}$  (width of cut 1.25 to 6mm / lead angle  $0^\circ$ ,  $5^\circ$ )
- Available in 10 chipbreaker styles and 11 insert grades for diverse machining applications
- New** ■ Series now includes Holders for Deep Grooves GNDXL type, supporting deep grooves up to 32mm

# Grooving Tool Holders GND Series



## Characteristics

- Wide range of application processes  
For grooving, turning, copying, facing, boring and cut-off.
- Stable tool life  
An array of chipbreakers improves the efficiency in chip control in various applications and prevents unexpected damage caused by chip blockade.
- Smooth cutting and high efficiency machining  
Holders utilizing one-piece body construction made of special steel, reduce vibration by 30 % during machining as compared to conventional types.
- High precision grooving widths with moulded inserts  
Grooving insert width tolerance of  $\pm 0,03$  mm over the entire range

## Cutting Performance

### Eliminates Vibration

Reduces vibration up to 30 % compared to conventional steels thanks to its high-rigidity design.

Special die steel



Single-piece construction

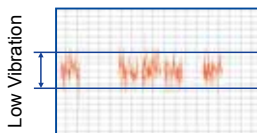

GND Type

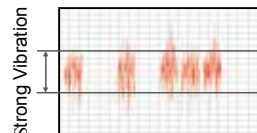

Conventional Tool

Work Material: 15CrMo5  
Holder: GNDL R2525M 220  
Insert: GCM N2002 GG  
Cutting Conditions:  $v_c = 100$  m/min,  $f = 0,10$  mm/rev,  $a_p = 20$  mm, wet

### Ensures both, high rigidity and good chip evacuation

#### Internal

Wide pocket improves chip evacuation

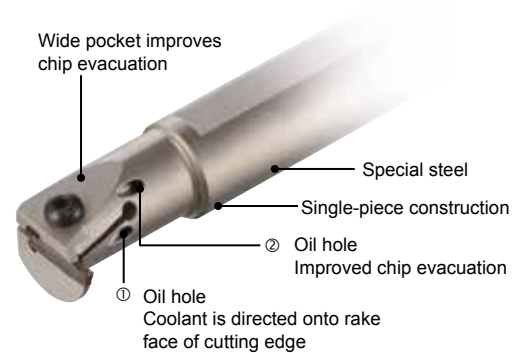

Stable, Reduced Vibration

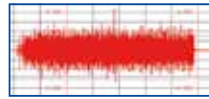

GND Type

Unstable Vibration

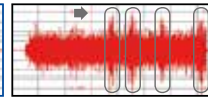

Comp. A

Large Vibration

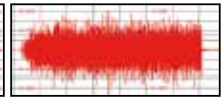

Comp. B

Work Material: 15CrMo5  
Holder: GNDI R2532 T306  
Insert: GCM N3002 GG  
Cutting Conditions:  $v_c = 100$  m/min,  $f = 0,05$  mm/rev,  $a_p = 3,0$  mm, wet

## Application Examples

Substantially improved machining efficiency!

High rigidity holder enables high load machining at high feed rate.

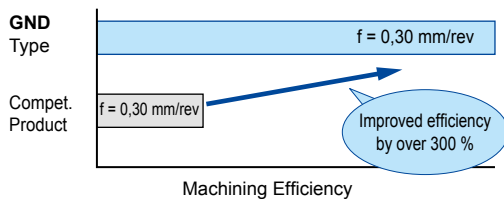

Work Material: 42CrMo4  
Holder: GNDL R2525M 320  
Insert: GCM N3002 GG (AC530U)  
Cutting Conditions:  $v_c = 130$  m/min,  $f = 0,30$  mm/rev, wet

Stable and long tool life ensures reliable functionality even on automatic production lines!

Reduction of chattering prevents unexpected breakage.

Normal Wear



GND Type

Breakage



Competitor

Work Material: C53  
Holder: GNDM L2525M 618  
Insert: GCM N6030 RG (AC530U)  
Cutting Conditions:  $v_c = 130$  m/min,  $f = 0,30$  mm/rev, wet

## ■ New Holders for Deep Grooves GNDXL type New

- SEC-Grooving Tools GND series now feature holders for deep grooves with groove depth up to **32mm**
- Integrated high-rigidity body and insert realise superb vibration resistance with extra-strong clamp-on specifications
- Shank width lineup includes **20mm square** and **25mm square**
- Dedicated **1-cornered inserts** for deep grooving with **widths of cut from 3.0 to 6.0mm** are stocked (2.0 mm is a made-to-order item)
- Chipbreaker lineup includes ML type / GF type / RN type

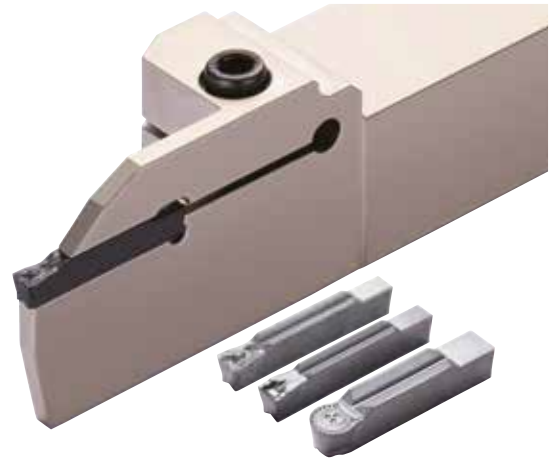

## ■ Vibration Resistance

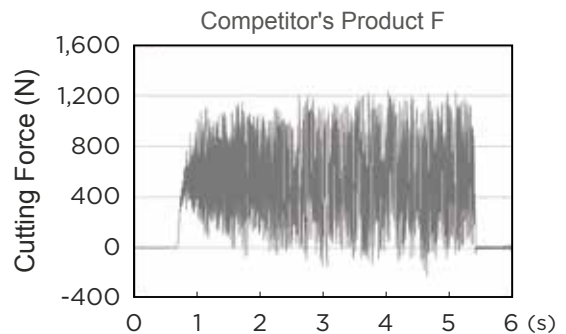
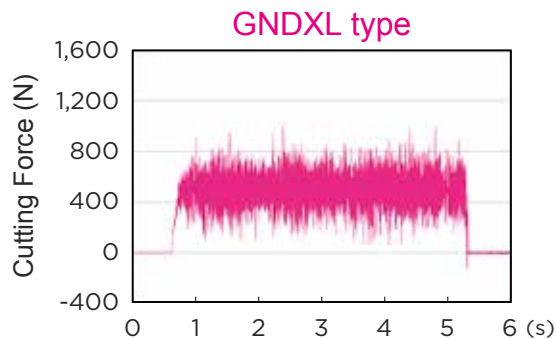

Work Material: X5CrNiMo17-12-2 Holder: GNDXL R2525M-332 Insert: GCMN3002-GF1 (AC530U) Cutting Conditions:  $v_c=100\text{m/min}$   $f=0.10\text{mm/rev}$   $a_p=10\text{mm}$  Wet (External Coolant Supply)

# Grooving Tool Holders

## GND Series

### ■ Inserts - Chipbreaker Series

Achieving stability and longer tool life. A variety of chipbreakers ensures outstanding chip control performance in many different types of applications.

Grooving / Turning			Grooving / Cut-Off			Cut-Off		Profiling	Necking	Non Ferrous Metals
General Type	Low Feed Type		General Type	Low Feed Type	Low Cutting ForceType	Cut-Off Type	Low Cutting ForceType	General Type	General Type	General Type
<b>MG</b>	<b>ML</b>		<b>GG</b>	<b>GL</b>	<b>GF</b>	<b>CG</b>	<b>CF</b>	<b>RG</b>	<b>RN</b>	<b>GA</b>
Cross Section of Cutting Edge	Cross Section of Cutting Edge		Cross Section of Cutting Edge	Cross Section of Cutting Edge	Cross Section of Cutting Edge	Cross Section of Cutting Edge	Cross Section of Cutting Edge	Cross Section of Cutting Edge	Cross Section of Cutting Edge	Cross Section of Cutting Edge
Grooving Width (mm)	Grooving Width (mm)		Grooving Width (mm)	Grooving Width (mm)	Grooving Width (mm)	Grooving Width (mm)	Grooving Width (mm)	Grooving Width (mm)	Grooving Width (mm)	Grooving Width (mm)
1,25   1,5   2,0	1,25   1,5   2,0		1,25   1,5   2,0	1,25   1,5   2,0	1,25   1,5   2,0	1,25   1,5   2,0	1,25   1,5   2,0	1,25   1,5   2,0	1,25   1,5   2,0	1,25   1,5   2,0
3,0   4,0   5,0	3,0   4,0   5,0		3,0   4,0   5,0	3,0   4,0   5,0	3,0   4,0   5,0	3,0   4,0   5,0	3,0   4,0   5,0	3,0   4,0   5,0	3,0   4,0   5,0	3,0   4,0   5,0
6,0   7,0   8,0	6,0   7,0   8,0		6,0   7,0   8,0	6,0   7,0   8,0	6,0   7,0   8,0	6,0   7,0   8,0	6,0   7,0   8,0	6,0   7,0   8,0	6,0   7,0   8,0	6,0   7,0   8,0
Grade	Grade		Grade	Grade	Grade	Grade	Grade	Grade	Grade	Grade
AC8025P   AC8035P	AC8025P   AC8035P		AC8025P   AC8035P	AC8025P   AC8035P	AC8025P   AC8035P	AC8025P   AC8035P	AC8025P   AC8035P	AC8025P   AC8035P	AC8025P   AC8035P	AC8025P   AC8035P
AC830P   AC425K	AC830P   AC425K		AC830P   AC425K	AC830P   AC425K	AC830P   AC425K	AC830P   AC425K	AC830P   AC425K	AC830P   AC425K	AC830P   AC425K	AC830P   AC425K
AC5015S   AC5025S	AC5015S   AC5025S		AC5015S   AC5025S	AC5015S   AC5025S	AC5015S   AC5025S	AC5015S   AC5025S	AC5015S   AC5025S	AC5015S   AC5025S	AC5015S   AC5025S	AC5015S   AC5025S
AC520U   AC530U	AC520U   AC530U		AC520U   AC530U	AC520U   AC530U	AC520U   AC530U	AC520U   AC530U	AC520U   AC530U	AC520U   AC530U	AC520U   AC530U	AC520U   AC530U
AC1030U   T2500A	AC1030U   T2500A		AC1030U   T2500A	AC1030U   T2500A	AC1030U   T2500A	AC1030U   T2500A	AC1030U   T2500A	AC1030U   T2500A	AC1030U   T2500A	AC1030U   T2500A
H10	H10		H10	H10	H10	H10	H10	H10	H10	H10

  Stock      \* Only use with GNDIS

### ■ Recommended Cutting Conditions

Work Material	<b>P</b> Carbon Steel / Alloy Steel	<b>M</b> Stainless Steel	<b>K</b> Cast Iron	<b>S</b> Exotic Alloy	<b>N</b>
Grade	AC830P AC8025P AC8035P	AC520U AC530U AC1030U	AC830P AC5015S AC5025S	AC520U AC530U AC1030U	AC520U AC5015S AC5025S AC530U AC1030U
Cutting Speed (m/min)	80-200	80-200	50-200	50-200	70-150

Please see cutting data page 13

### ■ Excellent Chip Control

**Grooving**



**GND Type**  
(GG Type Chipbreaker)



Conventional Tool

Work Material: 15CrMo5  
 Holder: GNDL R2525M 320  
 Insert: GCM N3002 GG  
 Cutting Conditions:  $v_c=100$  m/min,  $f=0,15$  mm/rev,  $a_p=12,0$  mm, wet

**Turning**



**GND Type**  
(ML Type Chipbreaker)



Conventional Tool

Work Material: 15CrMo5  
 Holder: GNDM R2525M 312  
 Insert: GCM N3002 ML  
 Cutting Conditions:  $v_c=100$  m/min,  $f=0,10$  mm/rev,  $a_p=0,5$  mm, wet

**Cut-Off**



**GND Type**  
(CG Type Chipbreaker)



Conventional Tool

Work Material: X5CrMo17122 (Ø 30 mm)  
 Holder: GNDL R2525M 220  
 Insert: GCM R2002 CG 05  
 Cutting Conditions:  $v_c=100$  m/min,  $f=0,15$  mm/rev, wet

**Profiling**

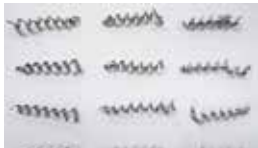

**GND Type**  
(RG Type Chipbreaker)















Conventional Tool

Work Material: 15CrMo5  
 Holder: GNDM R2525M 312  
 Insert: GCM N3015 RG  
 Cutting Conditions:  $v_c=100$  m/min,  $f=0,15$  mm/rev,  $a_p=0,1$  mm, wet

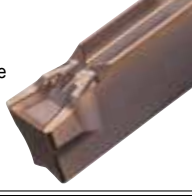

## Chipbreaker Selection

	Grooving / Turning	Grooving	Cut-Off
1st Recommendation	<b>MG</b> General Feed 	<b>GG</b> General Feed 	<b>GG</b> General Feed 
	Improved Chip Control Chipping Prevention	Improved Chip Control Chipping Prevention	Prevent Nip Formation Good Chip Control Improved Chip Control Chipping Prevention
2nd Recommendation	<b>ML</b> Low Feed Good Chip Control 	<b>GL</b> General Feed Good Chip Control 	<b>GL</b> General Feed Good Chip Control 
		Good Chip Control Reduce Chattering Chipping Prevention	Prevent Nip Formation Chipping Prevention Good Chip Control Reduce Chattering Chipping Prevention
		<b>GF</b> Low Cutting Force 	<b>CF</b> Low Cutting Force Feed Direction Front Cutting Edge Angle 10°/15° 
			<b>GF</b> Low Cutting Force 
	Profiling / Radius Grooving Outside Diameter	Necking / Radius Grooving Internal Profiling	For Non Ferrous Metals
Recommendation	<b>RG</b> General Feed 1st Recommendation 	<b>RN</b> General Feed 2nd Recommendation w = 2 mm 	<b>RN</b> General Feed 
			<b>GA</b> General Feed 

## Grade Selection

Cutting Process	<b>P</b> Steel	<b>M</b> Stainless Steel	<b>K</b> Cast Iron	<b>S</b> Exotic Alloy	<b>N</b> Non Ferrous Metals
Continuous, high speed ↑ ↓ Interrupted, unstable	<b>AC8025P</b> CVD	<b>AC8035P</b> (AC830P) CVD	1st Recommendation <b>AC425K</b> CVD	<b>AC5015S</b> PVD	1st Recommendation <b>H10</b> Uncoated Carbide
	<b>AC8035P</b> (AC830P) CVD	<b>AC5015S</b> PVD	<b>AC8025P</b> CVD	1st Recommendation <b>AC5025S</b> (AC520U) PVD	
	<b>AC5025S</b> (AC520U) PVD	1st Recommendation <b>AC5025S</b> (AC520U) PVD	<b>AC5015S</b> PVD	<b>AC5025S</b> (AC520U) PVD	
	1st Recommendation <b>AC530U/AC1030U</b> PVD	<b>AC530U</b> <b>AC1030U</b> PVD	<b>AC5025S</b> (AC520U) PVD	<b>AC530U</b> <b>AC1030U</b> PVD	

Only AC520U and AC1030U are stocked for inserts of GNDIS holders.





# Grooving Tool Holders

## GNDMS / GNDLS / GNDCM (JE) Type

### For External Machining (L Type)

#### Turning / Profiling

**GNDMS**

L Type  
Shank Size  
Height x Width  
20 mm x 20 mm  
25 mm x 25 mm

→ 24

Grooving Width (mm)		
1,25	1,5	2,0
3,0	4,0	5,0
6,0	7,0	8,0

Chipbreaker  
MG ML GG GL GF CG CF RG RN GA

#### Grooving / Cut-Off

**GNDLS**

L Type  
Shank Size  
Height x Width  
20 mm x 20 mm  
25 mm x 25 mm

→ 28

Grooving Width (mm)		
1,25	1,5	2,0
3,0	4,0	5,0
6,0	7,0	8,0

Chipbreaker  
MG ML GG GL GF CG CF RG RN GA

### Series for External Machining (L Type)

Type	Shank Size Height x Width	Cutting Width (mm)	Series	Max. Grooving Depth (mm)						Ref. Page	Applicable Chipbreaker												
				5	10	15	20	25	30		MG	ML	GG	GL	GF	CG	CF	RG	RN	GA			
L Type	20	20	2	GNDLS	16						28												
			3	GNDMS	10						24												
		3	GNDLS	16						28													
		4	GNDMS	12						24													
		5	GNDMS	12						24													
		2	GNDLS	18						28													
	25	25	3	GNDMS	12						24												
			3	GNDLS	18						28												
		4	GNDMS	14						24													
		4	GNDLS	23						28													
		5 6	GNDMS	14						24													
		5 6	GNDLS	23						28													

■ Stock      ○ 1st Recommendation      ○ 2nd Recommendation

### Cassettes for Radial Machining

#### Grooving

**GNDCM**

Cassette  
Applicable Holder  
SumiPolygon  
PSC 00 (Straight)  
PSC 90 (L Type)

→ 44

Grooving Width (mm)		
1,25	1,5	2,0
3,0	4,0	5,0
6,0	7,0	8,0

Chipbreaker  
MG ML GG GL GF CG CF RG RN GA

**GNDCM-JE**

Cassette  
Applicable Holder  
SumiPolygon  
PSC 00 (Straight)  
PSC 90 (L Type)

→ 46

Grooving Width (mm)		
1,25	1,5	2,0
3,0	4,0	5,0
6,0	7,0	8,0

Chipbreaker  
MG ML GG GL GF CG CF RG RN GA

### Radial Grooving Cassettes

Type	Applicable Holders	Cutting Width (mm)	Series	Max. Grooving Depth (mm)						Ref. Page	Applicable Chipbreaker											
				5	10	15	20	25	30		MG	ML	GG	GL	GF	CG	CF	RG	RN	GA		
Cassette	GND00	2	GNDCM(JE)	12						44/46												
		3	GNDCM(JE)	12						44/46												
	GND90	4	GNDCM(JE)	18						44/46												
		5 6	GNDCM(JE)	18						44/46												

■ Stock      ○ 1st Recommendation      ○ 2nd Recommendation





# Grooving Tool Holders

## GNDN Type

### For Necking

**GNDN**  
Straight Type

Shank Size  
Height x Width  
20 mm x 20 mm  
25 mm x 25 mm

→ 32

Grooving Width (mm)		
1,25	1,5	2,0
3,0	4,0	5,0
6,0	7,0	8,0

Chipbreaker  
MG ML GG GL GF CG CF FRG RN GA

### Series for Necking

Type	Shank Size		Cutting Width (mm)					Series	Max. Grooving Depth (mm)					Min. Bore (mm)	Ref. Page	Applicable Chipbreaker									
	Height	Width	2	3	4	5	6		5	10	15	20	25			30	MG	ML	GG	GL	GF	CG	CF	FRG	RN
Straight Type	20	20	2					2,0						ø20	32										
			25	25		3				2,5					ø20	32									
						4			3,0					ø30	32										
							5		3,5					ø30	32										
							6		4,0					ø30	32										

Stock

### Tips for Necking

#### Notes for Undercutting

Recommended Chipbreaker: RN

#### Distance between Workpiece and Necking

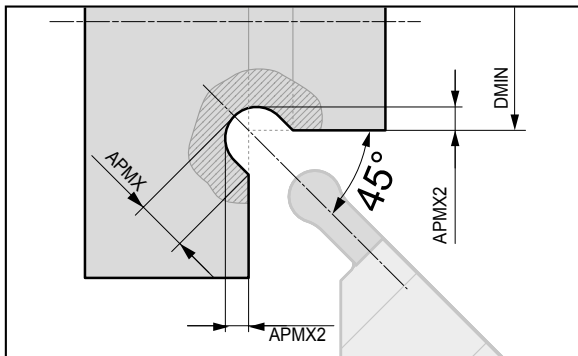

Edge Width CW (mm)	Depth of Necking APMX (mm)	Distance between Workpiece and Necking APMX2 (mm)
2,0	1,50	0,64
3,0	2,00	0,79
4,0	3,00	1,29
5,0	3,50	1,44
6,0	4,00	1,59

The recommended cutting conditions for necking are the same as grooving with RN type chipbreaker and edge width. To prevent interference with the work material, do not use the holder for less than the minimum cutting diameter (DMIN) as specified for GNGN type holders.

#### Chip Shape

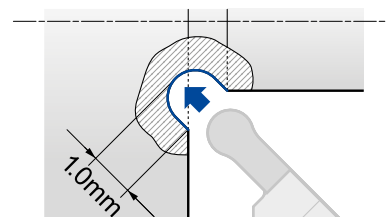

Work Material: 34CrMo4  
Holder: GNDN R2020K 325-020  
Insert: GCM N3015 RN  
Cutting Conditions:  $v_c = 100\text{m/min}$ ,  $f = 0,1\text{mm/rev}$   
Depth of Necking = 1,0mm, wet

## Cassettes for Face Machining

### Face Grooving / Turning / Profiling

**GNDCF**  
Cassette

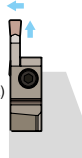

Applicable Holder  
SumiPolygon  
PSC 00 (Straight)  
PSC 90 (L Type)

→ 48

Grooving Width (mm)		
1,25	1,5	2,0
3,0	4,0	5,0
6,0	7,0	8,0

Chipbreaker

MG ML GG GL GF CG CF RG RN GA

**GNDCF(E)**  
Cassette

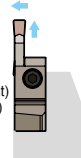

Applicable Holder  
SumiPolygon  
PSC 00 (Straight)  
PSC 90 (L Type)

→ 50

Grooving Width (mm)		
1,25	1,5	2,0
3,0	4,0	5,0
6,0	7,0	8,0

Chipbreaker

MG ML GG GL GF CG CF RG RN GA

### Face Grooving Cassettes

Type	Cutting Width (mm)							Series	Max. Grooving Depth (mm)					Bore (mm)					Ref. Page	Applicable Chipbreaker											
	3	4	5	6	7	8	5		10	15	20	30	50	100	150	200	300	1.000		MG	ML	GG	GL	GF	CG	CF	RG	RN	GA		
Straight Type	3							GNDCF GNDCF(E)	12					ø40 ø55					48/50	○	○	○	○	○						○	○
	3								15					ø50 ø75					48/50	○	○	○	○	○						○	○
	3								15					ø65 ø100					48/50	○	○	○	○	○						○	○
	3								18					ø90 ø150					48/50	○	○	○	○	○						○	○
	3								18					ø140 ø200					48/50	○	○	○	○	○						○	○
	4								18					ø40 ø55					48/50	○	○	○	○	○						○	○
	4								18					ø50 ø70					48/50	○	○	○	○	○						○	○
	4								18					ø65 ø90					48/50	○	○	○	○	○						○	○
	4								18					ø85 ø130					48/50	○	○	○	○	○						○	○
	4								18					ø125 ø200					48/50	○	○	○	○	○						○	○
	4								18					ø180 ø300					48/50	○	○	○	○	○						○	○
	5								18					ø50 ø70					48/50	○	○	○	○	○						○	○
	5								18					ø65 ø90					48/50	○	○	○	○	○						○	○
	5								18					ø85 ø130					48/50	○	○	○	○	○						○	○
	5								18					ø125 ø200					48/50	○	○	○	○	○						○	○
	5								18					ø180 ø300					48/50	○	○	○	○	○						○	○
	6								18					ø50 ø75					48/50	○	○	○	○	○						○	○
	6								18					ø70 ø110					48/50	○	○	○	○	○						○	○
	6								18					ø100 ø200					48/50	○	○	○	○	○						○	○
	6								18					ø180 ø300					48/50	○	○	○	○	○						○	○
	6								18					ø280 ø1.000					48/50	○	○	○	○	○						○	○

■ Stock     
  Make to order item     
 ○ 1st Recommendation      ○ 2nd Recommendation

# Grooving Tool Holders

## GNDI / GNDIS Type

For Internal Machining ( $\geq \varnothing 14$  mm)

Grooving / Turning / Copying

GNDIS  
Straight Type

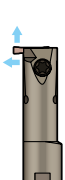

$\varnothing 12$  mm  
 $\varnothing 16$  mm  
 $\varnothing 20$  mm  
 → 40

Grooving Width (mm)		
1,5	2,0	3,0

Chipbreaker	
ML	GF

For Internal Machining ( $\geq \varnothing 32$  mm)

Grooving / Turning / Copying

GNDI  
Straight Type

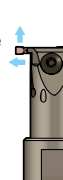

$\varnothing 25$  mm  
 $\varnothing 32$  mm  
 $\varnothing 40$  mm  
 → 38

Grooving Width (mm)		
1,25	1,5	2,0
3,0	4,0	5,0
6,0	7,0	8,0

Chipbreaker									
MG	ML	GG	GL	GF	CG	CF	RG	RN	GA

### Series for Internal Machining ( $\geq \varnothing 14$ mm)

Type	Shank Size (mm)	Cutting Width (mm)			Series	Max. Grooving Depth (mm)	Min. Bore (mm)	Ref. Page	Applicable Chipbreaker			
		1,5	2	3					ML	GF		
Straight Type	$\varnothing 12$	1,5			GNDIS	2,6	$\varnothing 14$	40		○		
						3,6	$\varnothing 14$	40		○		
		2	3	2,6		$\varnothing 14$	40	○	○			
				3,6		$\varnothing 14$	40	○	○			
		$\varnothing 16$	1,5				GNDIS	3,6	$\varnothing 16$	40		○
								4,6	$\varnothing 20$	40		○
	2		3	3,6	$\varnothing 16$	40		○	○			
				4,6	$\varnothing 20$	40		○	○			
	$\varnothing 20$		1,5			GNDIS		6,6	$\varnothing 25$	40		○
								6,6	$\varnothing 25$	40	○	○

Stock

GNDIS type: use smaller GXM type inserts

○ 1st Recommendation

### Series for Internal Machining ( $\geq \varnothing 32$ mm)

Type	Shank Size (mm)	Cutting Width (mm)						Series	Max. Grooving Depth (mm)	Min. Bore (mm)	Ref. Page	Applicable Chipbreaker											
		2	3	4	5	6	MG					ML	GG	GL	GF	CG	CF	RG	RN	GA			
Straight Type	$\varnothing 25$	2					GNDI	6	$\varnothing 32$	38		○	○	○	○					○	○		
								6	$\varnothing 32$	38	○	○	○	○					○	○			
		3	4	5	6	$\varnothing 32$		38	○	○	○	○					○	○					
					10	$\varnothing 40$		38	○	○	○	○					○	○					
		$\varnothing 32$	2							GNDI	11	$\varnothing 50$	38	○	○	○	○					○	○
											11	$\varnothing 50$	38	○	○	○	○					○	○

Stock

○ 1st Recommendation

○ 2nd Recommendation

## Chipbreaker Selection Guide

Groov. Width (mm)	Recommended Cutting Conditions		Nose Radius (mm)	Chipbreaker
	Grooving	Turning		
1,25			0,05	MGMLGGGLGFCCFCFRNGA
1,5			0,05	MGMLGGGLGFCCFCFRNGA
2,0			0,03	MGMLGGGLGFCCFCFRNGA
			0,2	MGMLGGGLGFCCFCFRNGA
			1,0	MGMLGGGLGFCCFCFRNGA
3,0			0,03	MGMLGGGLGFCCFCFRNGA
			0,2	MGMLGGGLGFCCFCFRNGA
			0,4	MGMLGGGLGFCCFCFRNGA
			1,5	MGMLGGGLGFCCFCFRNGA
4,0			0,2	MGMLGGGLGFCCFCFRNGA
			0,4	MGMLGGGLGFCCFCFRNGA
			0,8	MGMLGGGLGFCCFCFRNGA
			2,0	MGMLGGGLGFCCFCFRNGA
5,0			0,2	MGMLGGGLGFCCFCFRNGA
			0,4	MGMLGGGLGFCCFCFRNGA
			0,8	MGMLGGGLGFCCFCFRNGA
			2,5	MGMLGGGLGFCCFCFRNGA
6,0			0,2	MGMLGGGLGFCCFCFRNGA
			0,4	MGMLGGGLGFCCFCFRNGA
			0,8	MGMLGGGLGFCCFCFRNGA
			3,0	MGMLGGGLGFCCFCFRNGA
7,0			0,2	MGMLGGGLGFCCFCFRNGA
			0,4	MGMLGGGLGFCCFCFRNGA
			0,8	MGMLGGGLGFCCFCFRNGA
			3,5	MGMLGGGLGFCCFCFRNGA
8,0			0,2	MGMLGGGLGFCCFCFRNGA
			0,4	MGMLGGGLGFCCFCFRNGA
			0,8	MGMLGGGLGFCCFCFRNGA
			4,0	MGMLGGGLGFCCFCFRNGA

## Recommended Cutting Conditions

Work Material	<b>P</b> Carbon Steel, Alloy Steel				<b>M</b> Stainless Steel			<b>K</b> Cast Iron			<b>S</b> Exotic Alloy		<b>N</b>
Grade	AC830P AC8025P AC8035P	AC520U	AC530U AC1030U	T2500A	AC830P	AC520U AC5015S AC5025S	AC530U AC1030U	AC425K	AC520U	AC530U AC1030U	AC520U AC5015S AC5025S	AC530U AC1030U	H10
Cutting Speed (m/min)	80-200	80-200	50-200	50-200	70-150	70-150	50-150	80-200	60-200	50-200	20-80	20-60	150-300



# Grooving Tool Holders

## GND Series

### Identification Details – Holders

**GND M R 25 25 (M) - (T) 3 12 (J/JE) (-035)**

①

Series Symbol
GND

②

Holder Design
Chart 3

③

Shank Width / Work Diameter
Chart 5

④

Application
Chart 2

⑤

Shank Height / Diameter
Chart 4

⑥

Type
Internal Grooving

⑦

Max. Grooving Depth
Chart 8

⑧

Min. Machining Diameter
(mm)

Application	
Chart 2	

Shank Height / Diameter	
Chart 4	

Shank Length	
Chart 6	

Insert Width	
Chart 7	

Coolant Supply	
JE: Internal Coolant (Screw Connection European Standard)	
J: Internal Coolant (Screw Connection Japanese Standard)	

② Application		
Symbol	Application	
S	External Multi-Purpose	Grooving/Cut Off/Turning/Profiling
M	External Multi-Purpose	Grooving/Cut Off/Turning/Profiling
L	External Grooving	Grooving/Cut Off
XL	External Deep Grooving	Grooving/Cut Off
MS	External L-Styled (Side Cut) Multi-Purpose	Grooving/Turning/Profiling
LS	External L-Styled (Side Cut) Deep Grooving	Grooving
N	Necking	Necking
I	Internal Grooving	Grooving/Turning/Profiling
IS	Internal Grooving	Grooving/Turning/Profiling
F	Face Grooving	Grooving/Turning/Profiling
FS	L-Shaped Tools for Facing	Grooving/Turning/Profiling
CM	Cassette for Polygon Holder	Radial Grooving
CF	Cassette for Polygon Holder	Face Grooving

③ Holder Design	
Symbol	Direction
R	Right
L	Left

④ Shank Height / Diameter		
Application	Symbol	Height (mm)
External/Face Grooving (Shank Height)	10	10
	12	12
	16	16
	20	20
	25	25
Internal Grooving (Shank Diameter)	25	25
	32	32
	40	40

⑤ Shank Width / Work Diameter		
Application	Symbol	Width (mm)
External/Face Grooving (Shank Width)	10	10
	12	12
	16	16
	20	20
	25	25
Internal Grooving (Shank Diameter)	32	32
	40	40
	50	50

⑥ Shank Length	
Symbol	Length (mm)
JX	120
K	125
M	150
P	170

⑧ Insert Width	
Symbol	Groov. Width (mm)
1,25	1,25
1,5	1,5
2	2,0
3	3,0
4	4,0
5	5,0
6	6,0
7	7,0
8	8,0

⑨ Max. Grooving Depth			
Symbol	Groov. Depth (mm)	Symbol	Groov. Depth (mm)
06	6,0	20	20,0
08	8,0	23	23,0
10	10,0	25	25,0
11	11,0		
12	12,0		
12,5	12,5		
14	14,0		
16	16,0		
18	18,0		

To ensure maximum rigidity, use the multi-purpose type holder to machine the maximum grooving depth.

### Identification Details – Inserts

**G C M N 30 02 (S) - G G -(1) -(05)**

①

Series Symbol
Grooving

②

Tolerance
G Class
M Class

③

Insert Design	
Symbol	Direction
N	Neutral
R	Right Hand
L	Left Hand

④

Front Relief Angle
C: 7°
X: Special

⑤

Insert Width	
Symbol	Groov. Width (mm)
125	1,25
150	1,5
20	2,0
30	3,0
40	4,0
50	5,0
60	6,0
70	7,0
80	8,0

⑥

Nose Radius	
Symbol	R (mm)
005	0,05
02	0,2
04	0,4
08	0,8
15	1,5
20	2,0
25	2,5
30	3,0

⑦

Applicable Holder	
Symbol	Holder
S	GNDIS

⑧

Chipbreaker	
Symbol	Application
MG	Multi-Purpose: General Feed
ML	Multi-Purpose: Low Feed
GG	Grooving: General Feed
GL	Grooving: Low Feed
GF	Grooving: Low Cutting Forces
CG	Cut-Off
CF	Cut-Off: Low Cutting Forces
RG	Copying: General Feed
RN	Multi-Purpose: General Feed
GA	Multi-Purpose: General Feed

⑨

Front Cutt. Edge Angle
PSI
05 : 5°
10 : 10°
15 : 15°

⑩

No. of Cutting Edges	
Symbol	No. of cutting edges
No.	2-cornered type
1	1-cornered type (GNDXL type Dedicated)

## Key Points for Face Machining

### Holder Selection

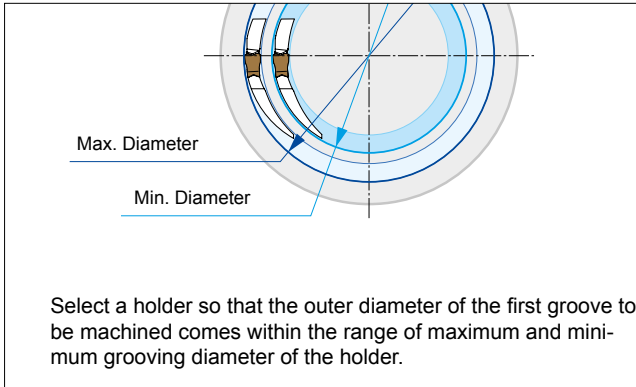

### Precautions for Groove Expansion

Recommended Chipbreaker: **MG, ML, GG, GL, GF**

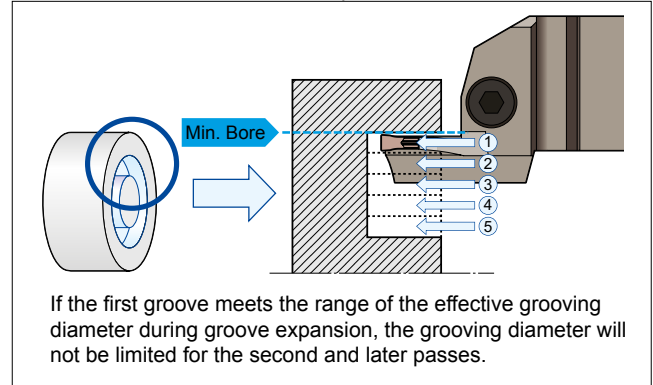

### Precautions for Turning

Recommended Chipbreaker:

**MG, ML**

Considering the rigidity of the holder, we recommend machining from the outside to the inside.

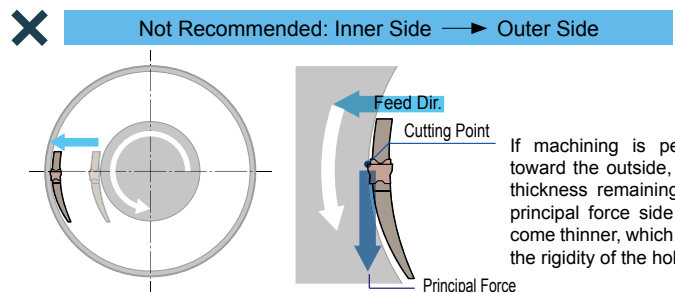
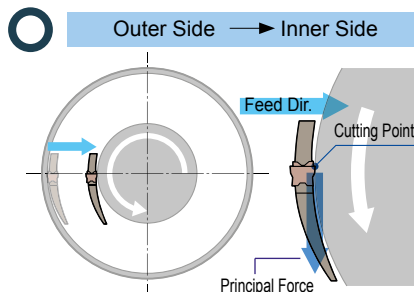

If machining is performed toward the outside, the wall thickness remaining on the principal force side will become thinner, which reduces the rigidity of the holder.

- If the first groove meets the range of the effective grooving diameter in face turning, the grooving diameter will not be limited for the second and later passes.
- Select the chipbreaker of the lower limit side of the recommended cutting conditions and straight chips before evacuation. (In face grooving, broken chips easily get stuck in grooves, which causes problems.)
- When breaking chips, step feed is required.

## Key Points for Internal Machining

### Precautions for Internal Machining

Recommended Chipbreaker:

**ML, GL**

If the prepared hole diameter is small, use an ML or GL low-feed chipbreaker, each of which reduces chip curl diameter, to ensure adequate chip evacuation.



Work Material: 15CrMo5 (Ø 25 mm)  
Holder: GNDI R2532 T306  
Insert: GCM N300 □-□□  
Cutting Conditions:  $v_c=100$  m/min,  $f=0,10$  mm/rev,  $a_p=3,0$  mm, wet



 Chip shapes differ between internal and external machining even under the same cutting conditions.

Work Material: 15CrMo5  
Holder: GNDL R2525M 320  
Insert: GCM N3002 GG  
Cutting Conditions:  $v_c=100$  m/min,  $f=0,10$  mm/rev,  $a_p=5$  mm, wet

# Grooving Tool Holders GND Series

## Precautions for Grooving Tool Holders GND Series

### Notes on how to Attach Inserts

- Remove any foreign particles or oil from the insert seat before attaching the insert.
- Ensure the seat location is clean and free of damage.
- Slide the insert level over its seat.
- Push the insert with its opposite end (the holder side) firmly against the insert stop end.
- The recommended tightening torque is 5 N.m. Tightening above the recommended torque may damage the insert or the holder which could cause injury and other accidents.

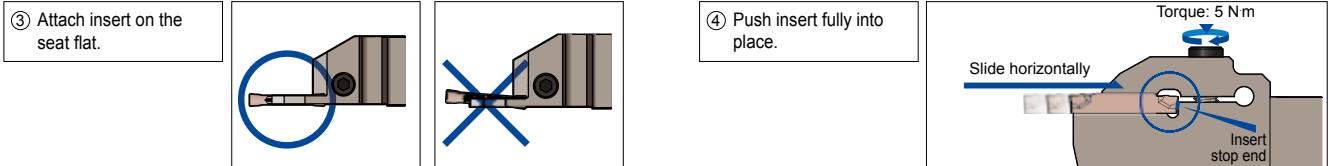

### Notes on how to Apply Holders

- Remove any foreign particles or oil from the tool post before attaching the holder.
- Ensure the seat location is clean and free of damage.
- Attach the holder so that the insert is perpendicular to the workpiece.
- Set holder with shortest possible overhang.
- When grooving or turning, adjust the center height of the cutting edge to as close  $\pm 0$  mm as possible. (Within  $\pm 0,1$  mm is recommended)
- Incorrect center height adjustment may cause chattering. (In cut-off applications, adjust the center height of the cutting edge to a value from 0,0 to +0,2 mm). A lower center height will result in larger nip at the center.

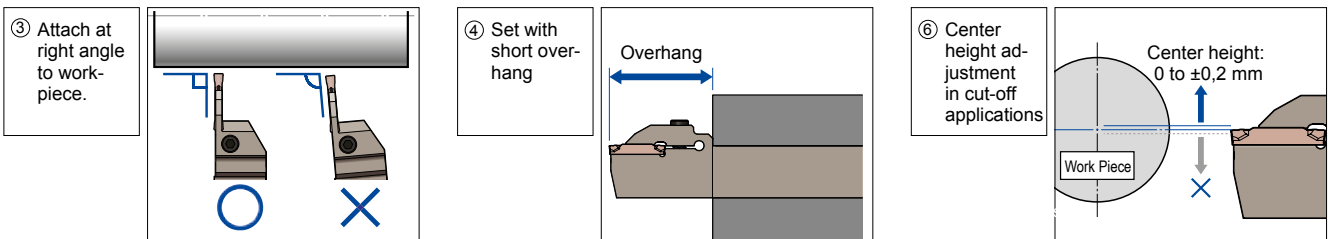

### Notes on Setting Coolant Supply Nozzle

Set the coolant supply nozzle so that coolant can be supplied from the top of the upper clamp unit.

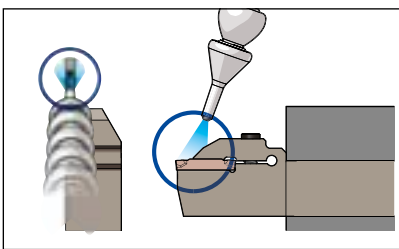

### Maximum Depth of Cut

Maximum depth of cut when pulling up with RG chipbreaker

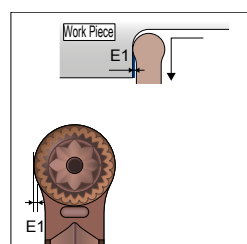

Grooving Width (mm)	Max. Depth of Cut (mm)
CW	E1
3,0	0,15
4,0	0,20
5,0	0,25
6,0	0,30
7,0	0,35
8,0	0,40

## Key Points of Internal Coolant-Type Holders for Small Lathes

The insert for internal coolant-type 12 mm and 16 mm holders for small lathes can be replaced from either the top or bottom.

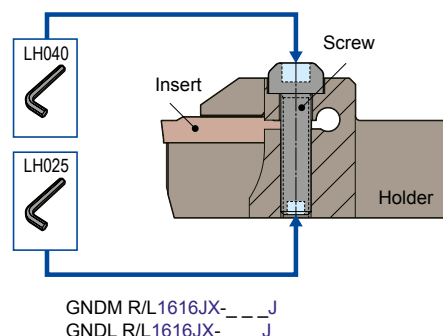
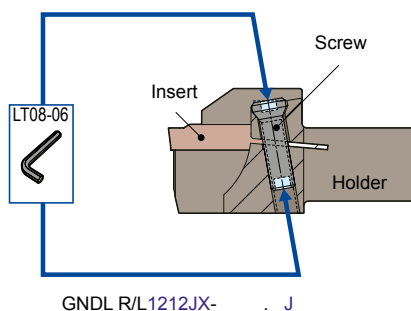

## Key Points for Connecting Hoses and Connectors

### ■ Connecting Hoses and Connectors

GNDM-JE (European standard)

Machine

Apply sealant such as commercial sealing tape to the piping connection parts.  
GNDM-JE type holders have a plug (XP02-E) mounted on the holder back end at shipping. (see fig. 1)  
When piping from the holder back end, mount a grub screw (BT0505-E) on the bottom of the holder for use. (see fig. 2)

Fig. 1 Piping from bottom

Fig. 2 Piping from back end

### ■ Connecting Hoses and Connectors (for Small Lathes)

GNDM-J (Japanese standard)

Equipment (small lathes, etc.)

Connector for hoseless coolant supply (supported products only)

Apply sealant such as commercial sealing tape to the piping connection parts.  
Refer to the figure below for mounting the plug during piping.

Piping from side (when shipped)

Piping from rear

Hoseless coolant support products (when shipped)

\* The plug will protrude a few millimeters when mounted to the side.

\* 1 The plug will protrude a few millimeters when mounted to the side.  
\* 2 A plug is attached when shipped. Remove this plug before supplying coolant without a hose.

### Holder with Hoseless Coolant Support

Direct coolant supply from the tool post is possible without a hose

Connector for Hoseless Coolant Supply

Remove the plug before supplying coolant without a hose.

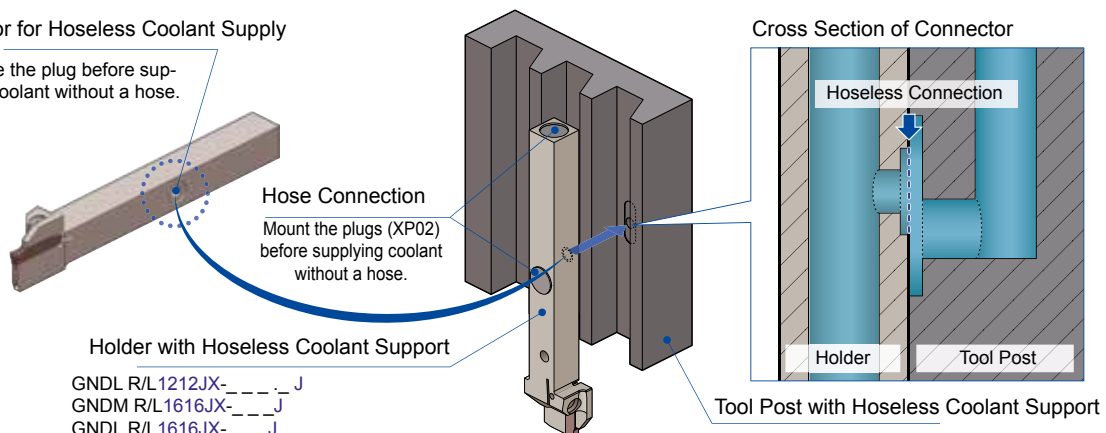

# Grooving Tool Holders GNDM / GNDL Type

## External General-Purpose Type for Small Lathes (Grooving, Turning, Profiling)

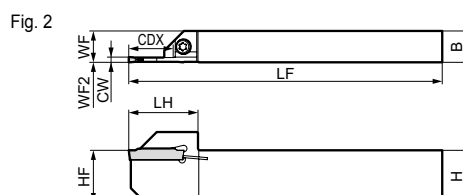
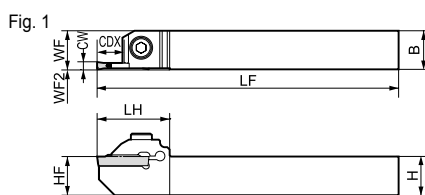
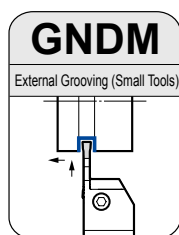

Above figures show right hand tools.

### Spare Parts

Use the multi-purpose profiling insert for turning (wide grooves).

### Holders

Cat. No.	Stock		Dimensions (mm)							Grooving Width (mm)	Max. Groov. Depth (mm)	Max. Cutt-Off Dia (mm)	Fig.	Applicable Insert	Cap Screw	N·m	Spanner
	R	L	H	B	LF	WF	HF	LH	WF2								
GNDM R/L 1616 JX 1.2508	●	●	16	16	120	(16)	16	26	0	1,25	8,0	16	1	GCM N125005 GF	BX0515	4,0	LH040
GNDM R/L 1616 JX 1.510	●	●	16	16	120	(16)	16	26	0	1,50	10,0	20					
GNDM R/L 1616 JX 212	●	●	16	16	120	(16)	16	30	0	2,00	12,0	24					
GNDM R/L 1616 JX 312	●	●	16	16	120	(16)	16	30	0	3,00	12,0	24					
GNDM R/L 2012 JX 217	○	○	20	12	120	(12)	20	26,5	0	2,00	17,0	34		2			
GNDM R/L 2012 JX 317	○	○	20	12	120	(12)	20	26,5	0	3,00	17,0	34					

Select holders and inserts with the same grooving width (CW).

## External Grooving / Cut-Off for Small Lathes

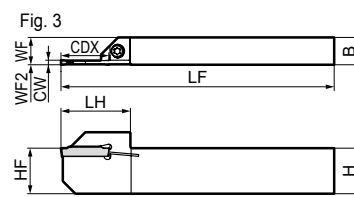
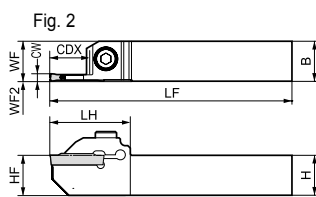
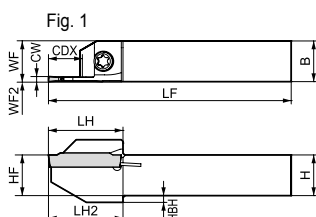
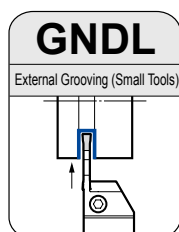

Above figures show right hand tools.

### Spare Parts

### Holders

Cat. No.	Stock		Dimensions (mm)									Grooving Width (mm)	Max. Groov. Depth (mm)	Max. Cutt-Off Dia (mm)	Fig.	Applicable Insert	Cap Screw	N·m	Spanner
	R	L	H	B	LF	WF	HF	HBH	LH	LH2	WF2								
GNDL R/L 1010 JX 1.2510	●	●	10	10	120	(10)	10	2,0	18	18,3	0	1,25	10,0	20	1	GCM N125005 GF	BFTX0412N	3,0	LT15-10
GNDL R/L 1010 JX 1.510	●	●	10	10	120	(10)	10	2,0	18	18,3	0	1,50	10,0	20					
GNDL R/L 1010 JX 210	●	●	10	10	120	(10)	10	2,0	22	22,3	0	2,00	10,0	20					
GNDL R/L 1010 JX 310	●	●	10	10	120	(10)	10	2,0	22	22,3	0	3,00	10,0	20					
GNDL R/L 1212 JX 1.2512	●	●	12	12	120	(12)	12	2,0	19	19,3	0	1,25	12,0	24		1			
GNDL R/L 1212 JX 1.512	●	●	12	12	120	(12)	12	2,0	19	19,3	0	1,50	12,0	24					
GNDL R/L 1212 JX 212.5	●	●	12	12	120	(12)	12	2,0	22	22,3	0	2,00	12,5	25					
GNDL R/L 1212 JX 312.5	●	●	12	12	120	(12)	12	2,0	22	22,3	0	3,00	12,5	25					
GNDL R/L 1616 JX 1.2512.5	○	●	16	16	120	(16)	16	-	28	-	0	1,25	12,5	25	2		GCM N125005 GF	BFTX0515	4,0
GNDL R/L 1616 JX 1.512.5	●	●	16	16	120	(16)	16	-	28	-	0	1,50	12,5	25					
GNDL R/L 1616 JX 216	●	●	16	16	120	(16)	16	-	32	-	0	2,00	16,0	32					
GNDL R/L 1616 JX 316	●	●	16	16	120	(16)	16	-	32	-	0	3,00	16,0	32					
GNDL R/L 2012 JX 221	○	○	20	12	120	(12)	20	-	30,5	-	0	2,00	21,0	42		3	GCM □20○-□□		
GNDL R/L 2012 JX 321	○	○	20	12	120	(12)	20	-	30,5	-	0	3,00	21,0	42					

Select holders and inserts with the same grooving width (CW).





# Grooving Tool Holders GNDM-J / GNDL-J Type

## Holder with Internal Coolant

### External Multi-Purpose Type for Small Lathes (Grooving, Turning, Profiling)

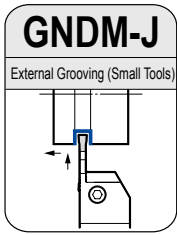

Use the multi-purpose profiling insert for turning (wide grooves).

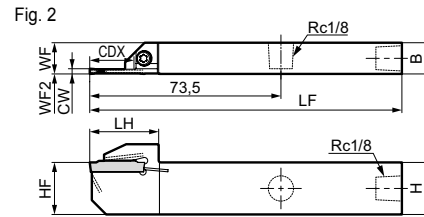
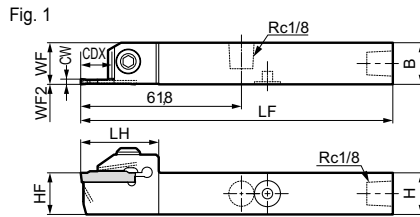

Above figures show right hand tools.

#### Spare Parts

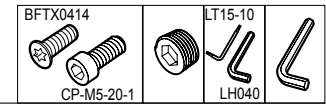

#### Holders

Cat. No.	Stock		Dimensions (mm)									Grooving Width (mm)	Max. Groov. Depth (mm)	Max. Cut-Off Dia (mm)	Fig.	Applicable Insert	Screw / Cap Screw	Plug	Wrench for Upper Surface	Wrench for Lower Surface
	R	L	H	B	LF	WF	HF	LH	WF2	CW	CDX									
GNDM R/L 1616 JX 212 J	○	○	16	16	120 (16)	16	30,0	0	2,0	12,0	24	1	GC □ 2000-□□	CP-M5-20-1	5,0	XP02	LH040	LH025		
GNDM R/L 1616 JX 312 J	○	○	16	16	120 (16)	16	30,0	0	3,0	12,0	24									
GNDM R/L 2012 JX 217 J	○	○	20	12	120 (12)	20	26,5	0	2,0	17,0	34		2						GC □ 2000-□□	
GNDM R/L 2012 JX 317 J	○	○	20	12	120 (12)	20	26,5	0	3,0	17,0	34								GC □ 3000-□□	

Select holders and inserts with the same grooving width (CW).

### External Grooving / Cut-Off for Small Lathes

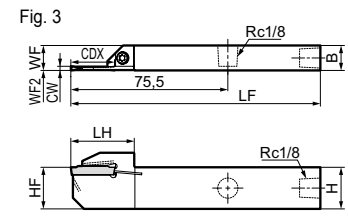
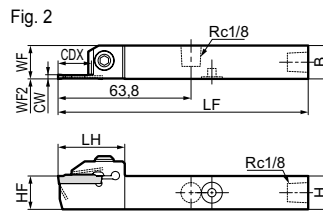
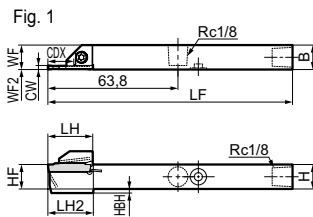
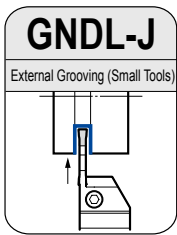

Above figures show right hand tools.

#### Spare Parts

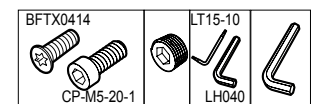

#### Holders

Cat. No.	Stock		Dimensions (mm)										Grooving Width (mm)	Max. Groov. Depth (mm)	Max. Cut-Off Dia (mm)	Fig.	Applicable Insert	Screw / Cap Screw	Plug	Wrench for Upper Surface	Wrench for Lower Surface
	R	L	H	B	LF	WF	HF	HBH	LH	LH2	WF2	CW									
GNDL R/L 1212 JX 212.5 J	○	○	12	12	120 (12)	12	2,0	22,0	22,3	0	2,0	12,5	25	1	GCM □ 2000-□□	BFTX0415T8R	1,5	XP02	LT08-06		
GNDL R/L 1212 JX 312.5 J	○	○	12	12	120 (12)	12	2,0	22,0	22,3	0	3,0	12,5	25								
GNDL R/L 1616 JX 216 J	○	○	16	16	120 (16)	16	-	32,0	-	0	2,0	16,0	32	2	GC □ 2000-□□	CP-M5-20-1	5,0	XP02	LH040		
GNDL R/L 1616 JX 316 J	○	○	16	16	120 (16)	16	-	32,0	-	0	3,0	16,0	32		GC □ 3000-□□						
GNDL R/L 2012 JX 221 J	○	○	20	12	120 (12)	20	-	30,5	-	0	2,0	21,0	42	3	GCM □ 2000-□□	BFTX0414	3,0	XP02	LT15-10		
GNDL R/L 2012 JX 321 J	○	○	20	12	120 (12)	20	-	30,5	-	0	3,0	21,0	42		GCM □ 3000-□□						

Select holders and inserts with the same grooving width (CW).

#### Parts (Hoses and Connectors)

See page 21

# Grooving Tool Holders GNDM-J / GNDL-J Type

## Inserts for GNDM-J / GNDL-J (Small Tools)

Coated Carbide    Cermet    Carbide

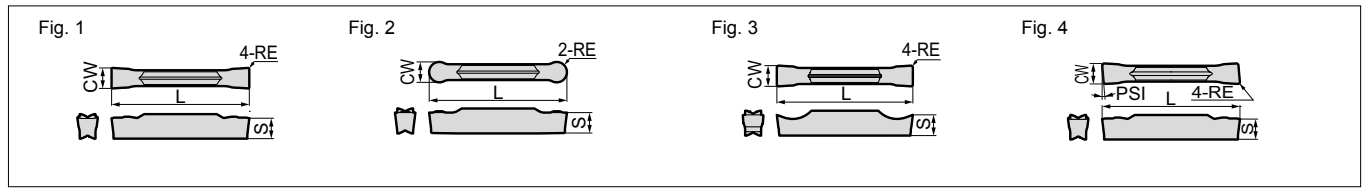

### Grooving / Traversing

Dimensions (mm)

Cat. No.	AC8025P	AC8035P	AC830P	AC425K	AC5015S	AC5025S	AC520U	AC530U	T2500A	CW		RE	L	S	Fig.
										Cutting Width	Tolerance				
GCM N3002 MG N3004 MG	●	●	●	○	●	●	○	○	○	3,0	±0.03 ±0.03	0,2 0,4	21,1 21,1	3,8 3,8	1
GCM N2002 ML N3002 ML N3004 ML	-	-	-	-	●	●	○	○	○	2,0 3,0	±0.03 ±0.03	0,2 0,2	21,1 21,1	3,6 3,8	1

### Grooving / Cut-Off Machining

Dimensions (mm)

Cat. No.	AC8035P	AC830P	AC5015S	AC5025S	AC520U	AC530U	T2500A	CW		RE	L	S	Fig.
								Cutting Width	Tolerance				
GCM N2002 GG N3002 GG N3004 GG	●	●	●	●	○	○	-	2,0 3,0	±0.03 ±0.03	0,2 0,4	21,1 21,1	3,6 3,8	1
GCM N2002 GL N2004 GL N3002 GL N3004 GL	●	●	●	●	○	○	-	2,0 3,0	±0.03 ±0.03	0,2 0,4	21,1 21,1	3,6 3,8	1
GCM N125005 GF N150005 GF	-	-	-	-	-	●	-	1,25 1,5	±0.03 ±0.03	0,05 0,05	17,4 17,4	3,2 3,7	1
GCM N2002 GF N2004 GF N3002 GF N3004 GF	-	-	●	●	○	○	○	2,0 3,0	±0.03 ±0.03	0,2 0,4	21,1 21,1	3,6 3,8	1

### External Profiling / External Radius Grooving

Dimensions (mm)

Cat. No.	AC8025P	AC8035P	AC830P	AC425K	AC5015S	AC5025S	AC520U	AC530U	T2500A	CW		RE	L	S	Fig.
										Cutting Width	Tolerance				
GCM N3015 RG	●	●	●	●	●	●	○	○	○	3,0	±0.03	1,5	21,1	3,8	2

### Cut-Off Machining (Handed Edge)

Dimensions (mm)

Cat. No.	AC8035P	AC830P	AC5015S	AC5025S	AC520U	AC530U	AC1030U	CW		RE	L	S	Fig.	
								Cutting Width	Tolerance					
GCM R2002 CG 05 L2002 CG 05	●	●	●	●	○	○	-	5° 5°	2,0 2,0	±0.03 ±0.03	0,2 0,2	21,1 21,1	3,6 3,6	4
GCM R3002 CG 05 L3002 CG 05	●	●	●	●	○	○	-	5° 5°	3,0 3,0	±0.03 ±0.03	0,2 0,2	21,3 21,3	3,8 3,8	
GCM R4002 CG 05 L4002 CG 05	●	●	●	●	○	○	-	5° 5°	4,0 4,0	±0.04 ±0.04	0,2 0,2	26,7 26,7	4,0 4,0	
GCM R20003 CF 10 L20003 CF 10	-	-	●	●	-	-	●	10° 10°	2,0 2,0	±0.08 ±0.08	0,03 0,03	22,4 22,4	3,6 3,6	
GCM R30003 CF 10 L30003 CF 10	-	-	●	●	-	-	●	10° 10°	3,0 3,0	±0.08 ±0.08	0,03 0,03	22,4 22,4	3,8 3,8	4
GCM R20003 CF 15 L20003 CF 15	-	-	●	●	-	-	●	15° 15°	2,0 2,0	±0.08 ±0.08	0,03 0,03	22,4 22,4	3,6 3,6	
GCM R30003 CF 15 L30003 CF 15	-	-	●	●	-	-	●	15° 15°	3,0 3,0	±0.08 ±0.08	0,03 0,03	22,4 22,4	3,8 3,8	

GCM R: Right hand    GCM L: Left hand  
Combine the insert with a holder such that the width of cut (CW) matches.

### Profiling / Radius Grooving / Necking

Dimensions (mm)

Cat. No.	AC8025P	AC8035P	AC830P	AC425K	AC5015S	AC5025S	AC520U	AC530U	T2500A	CW		RE	L	S	Fig.
										Cutting Width	Tolerance				
GCM N2010 RN N3015 RN	-	-	-	-	●	●	○	○	-	2,0 3,0	±0.03 ±0.03	1,0 1,5	21,7 22,6	3,6 3,8	2

### Non-Ferrous Metals

Dimensions (mm)

Cat. No.	H1	CW		RE	L	S	Fig.
		Cutting Width	Tolerance				
GCG N2002 GA N3002 GA	○	2,0 3,0	±0.025 ±0.025	0,2 0,2	21,1 21,1	3,6 3,8	3

## Parts (Hoses and Connectors)

### Parts Hoses

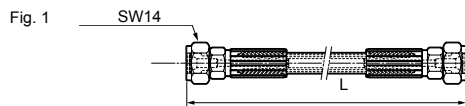

Cat. No.	Stock	L (mm)	Screw Standard	Screw Standard	Fig.
J-HOSE-G1/8-G1/8-200-E	●	200	G1/8	G1/8	1
J-HOSE-G1/8-G1/8-300-E	●	300	G1/8	G1/8	1

Hoses are sold separately.

### Parts (Connector) on Holder Side

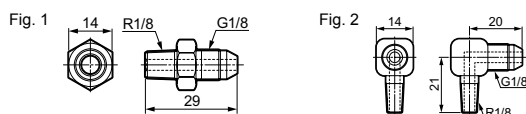

Cat. No.	Stock	Screw Standard	Screw Standard	Fig.
J-G1/8-R1/8-00	○	G1/8	R1/8	1
J-G1/8-R1/8-90	○	G1/8	R1/8	2

Connectors are sold separately.

### Parts (Connector) on Machine Side

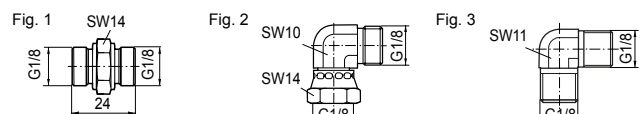

Cat. No.	Stock	Screw Standard	Screw Standard	Fig.
J-G1/8-G1/8-00-E	●	G1/8	G1/8	1
J-G1/8-G1/8F-90-E	●	G1/8	G1/8	2
J-G1/8-G1/8-90-E	●	G1/8	G1/8	3

Connectors are sold separately.

● Euro stock

○ Japan stock

□ Not available

# Grooving Tool Holders

## GNDS Type

### External Multi-Purpose Shallow Grooves Type (Grooving, Turning, Profiling)

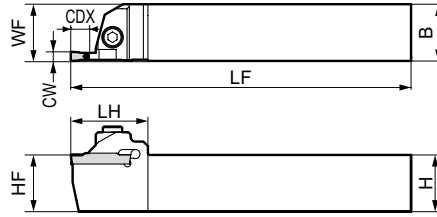
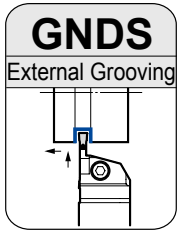

Use the multi-purpose profiling insert for turning (wide grooves).

Above figures show right hand tools.

### Spare Parts

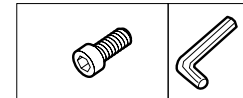

### ■ Holders

Cat. No.	Stock		Dimensions (mm)						Grooving Width (mm)	Max. Groov. Depth (mm)	Applicable Insert	Cap Screw	N·m	Spanner
	R	L	H	B	LF	WF	HF	LH						
GNDS R/L 2020 K 206	●	●	20	20	125	20	20	30	2,0	6	GCM □2000-□□	BX0520	5,0	LH040
GNDS R/L 2020 K 306	●	●	20	20	125	20	20	30	3,0	6	GCM □3000-□□			
GNDS R/L 2020 K 410	●	●	20	20	125	20	20	34	4,0	10	GCM □4000-□□			
GNDS R/L 2020 K 510	●	●	20	20	125	20	20	34	5,0	10	GCM N5000-□□			
GNDS R/L 2020 K 610	●	●	20	20	125	20	20	34	6,0	10	GCM N6000-□□			
GNDS R/L 2525 M 206	●	●	25	25	150	25	25	30	2,0	6	GCM □2000-□□			
GNDS R/L 2525 M 306	●	●	25	25	150	25	25	30	3,0	6	GCM □3000-□□			
GNDS R/L 2525 M 410	●	●	25	25	150	25	25	34	4,0	10	GCM □4000-□□			
GNDS R/L 2525 M 510	●	●	25	25	150	25	25	34	5,0	10	GCM N5000-□□			
GNDS R/L 2525 M 610	●	●	25	25	150	25	25	34	6,0	10	GCM N6000-□□			

Select holders and inserts with the same grooving width (CW).

# Grooving Tool Holders GNDS Type

## Inserts for GNDS

Coated Carbide    Cermet    Carbide

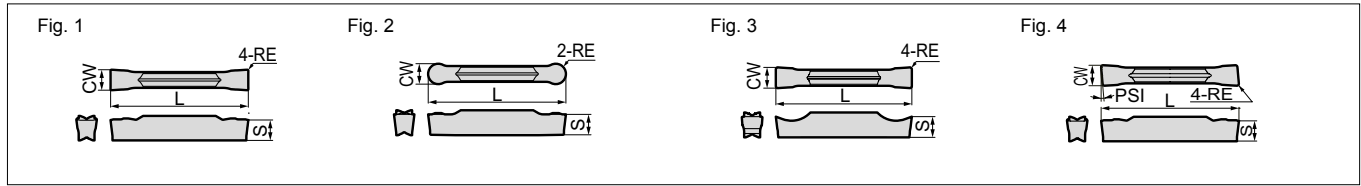

### Grooving / Traversing

Dimensions (mm)

Cat. No.	AC8025P	AC8035P	AC830P	AC425K	AC5015S	AC5025S	AC520U	AC530U	T2500A	CW		RE	L	S	Fig.
										Cutting Width	Tolerance				
GCM N3002 MG	●	●	●	○	●	●	○	●	—	3,0	±0,03	0,2	21,1	3,8	1
N3004 MG	●	●	●	○	●	●	○	●	—	±0,03	0,4	21,1	3,8		
N4002 MG	●	●	●	○	●	●	○	●	—	±0,03	0,2	26,4	4,0		
N4004 MG	●	●	●	○	●	●	○	●	—	4,0	±0,03	0,4	26,4	4,0	
N4008 MG	●	●	●	○	●	●	○	●	—	±0,03	0,8	26,4	4,0		
N5004 MG	●	●	●	○	●	●	○	●	—	5,0	±0,03	0,4	26,4	4,1	
N5008 MG	●	●	●	○	●	●	○	●	—	±0,03	0,8	26,4	4,1		
N6004 MG	●	●	●	○	●	●	○	●	—	6,0	±0,03	0,4	26,4	4,5	
N6008 MG	●	●	●	○	●	●	○	●	—	±0,03	0,8	26,4	4,5		
GCM N2002 ML	—	—	—	—	—	—	—	—	—	2,0	±0,03	0,2	21,1	3,6	1
N3002 ML	●	●	●	○	●	●	○	●	—	±0,03	0,2	21,1	3,8		
N3004 ML	●	●	●	○	●	●	○	●	—	±0,03	0,4	21,1	3,8		
N4002 ML	●	●	●	○	●	●	○	●	—	±0,03	0,2	26,4	4,0		
N4004 ML	●	●	●	○	●	●	○	●	—	4,0	±0,03	0,4	26,4	4,0	
N4008 ML	●	●	●	○	●	●	○	●	—	±0,03	0,8	26,4	4,0		
N5004 ML	●	●	●	○	●	●	○	●	—	5,0	±0,03	0,4	26,4	4,1	
N5008 ML	●	●	●	○	●	●	○	●	—	±0,03	0,8	26,4	4,1		
N6004 ML	●	●	●	○	●	●	○	●	—	6,0	±0,03	0,4	26,4	4,5	
N6008 ML	●	●	●	○	●	●	○	●	—	±0,03	0,8	26,4	4,5		

### Grooving / Cut-Off Machining

Dimensions (mm)

Cat. No.	AC8035P	AC830P	AC5015S	AC5025S	AC520U	AC530U	T2500A	CW		RE	L	S	Fig.
								Cutting Width	Tolerance				
GCM N2002 GG	●	●	●	●	●	●	—	2,0	±0,03	0,2	21,1	3,6	1
N3002 GG	●	●	●	○	●	●	—	±0,03	0,2	21,1	3,8		
N3004 GG	●	●	●	○	●	●	—	3,0	±0,03	0,4	21,1	3,8	
N4002 GG	●	●	●	○	●	●	—	4,0	±0,03	0,2	26,4	4,0	
N4004 GG	●	●	●	○	●	●	—	±0,03	0,4	26,4	4,0		
N5002 GG	●	●	●	○	●	●	—	5,0	±0,03	0,2	26,4	4,1	
N5004 GG	●	●	●	○	●	●	—	±0,03	0,4	26,4	4,1		
N6002 GG	●	●	●	○	●	●	—	6,0	±0,03	0,2	26,4	4,5	
N6004 GG	●	●	●	○	●	●	—	±0,03	0,4	26,4	4,5		
GCM N2002 GL	●	●	●	○	●	●	—	2,0	±0,03	0,2	21,1	3,6	1
N2004 GL	●	●	●	○	●	●	—	±0,03	0,4	21,1	3,6		
N3002 GL	●	●	●	○	●	●	—	3,0	±0,03	0,2	21,1	3,8	
N3004 GL	●	●	●	○	●	●	—	±0,03	0,4	21,1	3,8		
N4002 GL	●	●	●	○	●	●	—	4,0	±0,03	0,2	26,4	4,0	
N4004 GL	●	●	●	○	●	●	—	±0,03	0,4	26,4	4,0		
N5002 GL	●	●	●	○	●	●	—	5,0	±0,03	0,2	26,4	4,1	
N5004 GL	●	●	●	○	●	●	—	±0,03	0,4	26,4	4,1		
N6002 GL	●	●	●	○	●	●	—	6,0	±0,03	0,2	26,4	4,5	
N6004 GL	●	●	●	○	●	●	—	±0,03	0,4	26,4	4,5		
GCM N2002 GF	—	—	●	●	●	○	—	2,0	±0,03	0,2	21,1	3,6	1
N2004 GF	—	—	●	●	●	○	—	±0,03	0,4	21,1	3,6		
N3002 GF	●	●	●	○	●	●	—	3,0	±0,03	0,2	21,1	3,8	
N3004 GF	●	●	●	○	●	●	—	±0,03	0,4	21,1	3,8		
N4002 GF	●	●	●	○	●	●	—	4,0	±0,03	0,2	26,4	4,0	
N4004 GF	●	●	●	○	●	●	—	±0,03	0,4	26,4	4,0		
N5002 GF	●	●	●	○	●	●	—	5,0	±0,03	0,2	26,4	4,1	
N5004 GF	●	●	●	○	●	●	—	±0,03	0,4	26,4	4,1		
N6002 GF	●	●	●	○	●	●	—	6,0	±0,03	0,2	26,4	4,5	
N6004 GF	●	●	●	○	●	●	—	±0,03	0,4	26,4	4,5		

### External Profiling / External Radius Grooving

Dimensions (mm)

Cat. No.	AC8025P	AC8035P	AC830P	AC425K	AC5015S	AC5025S	AC520U	AC530U	T2500A	CW		RE	L	S	Fig.
										Cutting Width	Tolerance				
GCM N3015 RG	●	●	●	○	●	●	○	●	—	3,0	±0,03	1,5	21,1	3,8	2
N4020 RG	●	●	●	○	●	●	○	●	—	4,0	±0,03	2,0	26,4	4,0	
N5025 RG	●	●	●	○	●	●	○	●	—	5,0	±0,03	2,5	27,2	4,1	
N6030 RG	●	●	●	○	●	●	○	●	—	6,0	±0,03	3,0	27,5	4,5	

### Cut-Off Machining (Handed Edge)

Dimensions (mm)

Cat. No.	AC8035P	AC830P	AC5015S	AC5025S	AC520U	AC530U	AC1030U	CW		RE	L	S	Fig.	
								Cutting Width	Tolerance					
GCM R2002 CG 05	●	●	●	○	●	●	—	5°	2,0	±0,03	0,2	21,1	3,6	4
L2002 CG 05	●	●	●	○	●	●	—	5°	2,0	±0,03	0,2	21,1	3,6	
GCM R3002 CG 05	●	●	●	○	●	●	—	5°	3,0	±0,03	0,2	21,3	3,8	
L3002 CG 05	●	●	●	○	●	●	—	5°	3,0	±0,03	0,2	21,3	3,8	
GCM R4002 CG 05	●	●	●	○	●	●	—	5°	4,0	±0,04	0,2	26,7	4,0	
L4002 CG 05	●	●	●	○	●	●	—	5°	4,0	±0,04	0,2	26,7	4,0	
GCM R2003 CF 10	—	—	●	●	—	—	●	10°	2,0	±0,08	0,03	22,4	3,6	
L2003 CF 10	—	—	●	●	—	—	●	10°	2,0	±0,08	0,03	22,4	3,6	
GCM R3003 CF 10	—	—	●	●	—	—	●	10°	3,0	±0,08	0,03	22,4	3,8	
L3003 CF 10	—	—	●	●	—	—	●	10°	3,0	±0,08	0,03	22,4	3,8	
GCM R2003 CF 15	—	—	●	●	—	—	●	15°	2,0	±0,08	0,03	22,4	3,6	4
L2003 CF 15	—	—	●	●	—	—	●	15°	2,0	±0,08	0,03	22,4	3,6	
GCM R3003 CF 15	—	—	●	●	—	—	●	15°	3,0	±0,08	0,03	22,4	3,8	
L3003 CF 15	—	—	●	●	—	—	●	15°	3,0	±0,08	0,03	22,4	3,8	

GCM R: Right hand

GCM L: Left hand

Combine the insert with a holder such that the width of cut (CW) matches.

### Profiling / Radius Grooving / Necking

Dimensions (mm)

Cat. No.	AC8025P	AC8035P	AC830P	AC425K	AC5015S	AC5025S	AC520U	AC530U	T2500A	CW		RE	L	S	Fig.
										Cutting Width	Tolerance				
GCM N2010 RN	—	—	—	—	—	—	—	—	—	2,0	±0,03	1,0	21,7	3,6	2
N3015 RN	●	●	●	○	●	●	○	●	—	3,0	±0,03	1,5	22,6	3,8	
N4020 RN	●	●	●	○	●	●	○	●	—	4,0	±0,03	2,0	28,2	4,0	
N5025 RN	●	●	●	○	●	●	○	●	—	5,0	±0,03	2,5	28,3	4,1	
N6030 RN	●	●	●	○	●	●	○	●	—	6,0	±0,03	3,0	28,3	4,5	

### Non-Ferrous Metals

Dimensions (mm)

Cat. No.	H1	CW		RE	L	S	Fig.
		Cutting Width	Tolerance				
GCG N2002 GA	○	2,0	±0,025	0,2	21,1	3,6	3
N3002 GA	○	3,0	±0,025	0,2	21,1	3,8	
N4004 GA	○	4,0	±0,025	0,4	26,4	4,0	
N5004 GA	○	5,0	±0,025	0,4	26,4	4,1	
N6004 GA	○	6,0	±0,025	0,4	26,4	4,5	



# Grooving Tool Holders GNDM / GNDMS Type

## External Multi-Purpose Type (Grooving, Turning, Profiling)

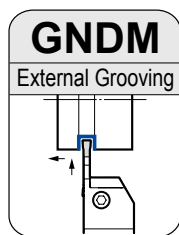

Use for multi-purpose or profiling insert for turning (wide grooves).

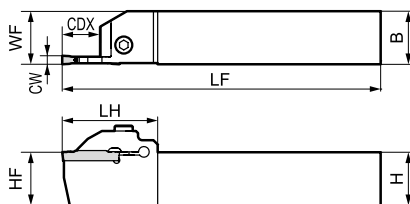

Above figures show right hand tools.

### Spare Parts

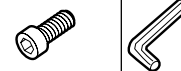

### Holders

Cat. No.	Stock		Dimensions (mm)						Grooving Width (mm)	Max. Groov. Depth (mm)	Max. Cutt-Off Dia (mm)	Applicable Insert	Cap Screw	N·m	Spanner
	R	L	H	B	LF	WF	HF	LH							
GNDM R/L 2020 K 1.2510	●	●	20	20	125	20	20	34,0	1,25	10	20	GCM N125005 GF	BX0520	5,0	LH040
GNDM R/L 2020 K 1.510	●	●	20	20	125	20	20	34,0	1,50	10	20	GCM N150005 GF			
GNDM R/L 2020 K 210	●	●	20	20	125	20	20	33,6	2,00	10	20	GCM □200○-□□			
GNDM R/L 2020 K 312	●	●	20	20	125	20	20	36,6	3,00	12	24	GCM □300○-□□			
GNDM R/L 2020 K 418	●	●	20	20	125	20	20	45,0	4,00	18	36	GCM □400○-□□			
GNDM R/L 2020 K 518	●	●	20	20	125	20	20	45,0	5,00	18	36	GCM N500○-□□			
GNDM R/L 2020 K 618	●	●	20	20	125	20	20	45,0	6,00	18	36	GCM N600○-□□			
GNDM R/L 2525 M 1.2510	●	●	25	25	150	25	25	36,0	1,25	10	20	GCM N125005 GF			
GNDM R/L 2525 M 1.510	●	●	25	25	150	25	25	36,0	1,50	10	20	GCM N150005 GF			
GNDM R/L 2525 M 210	●	●	25	25	150	25	25	33,6	2,00	10	20	GCM N200○-□□			
GNDM R/L 2525 M 312	●	●	25	25	150	25	25	36,6	3,00	12	24	GCM □300○-□□			
GNDM R/L 2525 M 418	●	●	25	25	150	25	25	45,0	4,00	18	36	GCM □400○-□□			
GNDM R/L 2525 M 518	●	●	25	25	150	25	25	45,0	5,00	18	36	GCM N500○-□□			
GNDM R/L 2525 M 618	●	●	25	25	150	25	25	45,0	6,00	18	36	GCM N600○-□□			
GNDM R/L 3225 P 312			32	25	170	25	32	36,6	3,00	12	24	GCM □300○-□□			
GNDM R/L 3225 P 418			32	25	170	25	32	45,0	4,00	18	36	GCM □400○-□□			
GNDM R/L 3225 P 518			32	25	170	25	32	45,0	5,00	18	36	GCM N500○-□□			
GNDM R/L 3225 P 618			32	25	170	25	32	45,0	6,00	18	36	GCM N600○-□□			
GNDM R/L 3225 P 718			32	25	170	25	32	50,0	7,00	18	36	GCM N700○-□□			
GNDM R/L 3225 P 818			32	25	170	25	32	50,0	8,00	18	36	GCM N800○-□□			
GNDM R/L 3232 P 312	●	●	32	32	170	32	32	36,6	3,00	12	24	GCM □300○-□□			
GNDM R/L 3232 P 418	●	●	32	32	170	32	32	45,0	4,00	18	36	GCM □400○-□□			
GNDM R/L 3232 P 518	●	●	32	32	170	32	32	45,0	5,00	18	36	GCM N500○-□□			
GNDM R/L 3232 P 618	●	●	32	32	170	32	32	45,0	6,00	18	36	GCM N600○-□□			
GNDM R/L 3232 P 718	●	●	32	32	170	32	32	50,0	7,00	18	36	GCM N700○-□□			
GNDM R/L 3232 P 818	●	●	32	32	170	32	32	50,0	8,00	18	36	GCM N800○-□□			

Select holders and inserts with the same grooving width (CW).

## External L-Styled (Side Cut) Multi-Purpose Type (Grooving, Turning, Profiling)

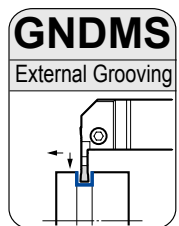

Use for multi-purpose or profiling insert for turning (wide grooves).

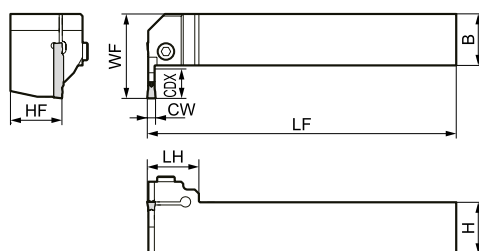

Above figures show right hand tools.

### Spare Parts

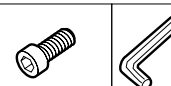

### Holders

Cat. No.	Stock		Dimensions (mm)						Grooving Width (mm)	Max. Groov. Depth (mm)	Applicable Insert	Cap Screw	N·m	Spanner
	R	L	H	B	LF	WF	HF	LH						
GNDMS R/L 2020 K 310	●	○	20	20	125	32	20	25	3,0	10	GCM □300○-□□	BX0520	5,0	LH040
GNDMS R/L 2020 K 412	●	●	20	20	125	34	20	25	4,0	12	GCM □400○-□□			
GNDMS R/L 2020 K 512	●	○	20	20	125	34	20	25	5,0	12	GCM N500○-□□			
GNDMS R/L 2525 M 312	●	●	25	25	150	39	25	25	3,0	12	GCM □300○-□□			
GNDMS R/L 2525 M 414	●	●	25	25	150	41	25	25	4,0	14	GCM □400○-□□			
GNDMS R/L 2525 M 514	●	●	25	25	150	41	25	25	5,0	14	GCM N500○-□□			
GNDMS R/L 2525 M 614	●	●	25	25	150	41	25	25	6,0	14	GCM N600○-□□			

Select holders and inserts with the same grooving width (CW).

● Euro stock

○ Japan stock

# Grooving Tool Holders GNDM / GNDMS Type

## Inserts for GNDM / GNDMS

Coated Carbide    Cermet    Carbide

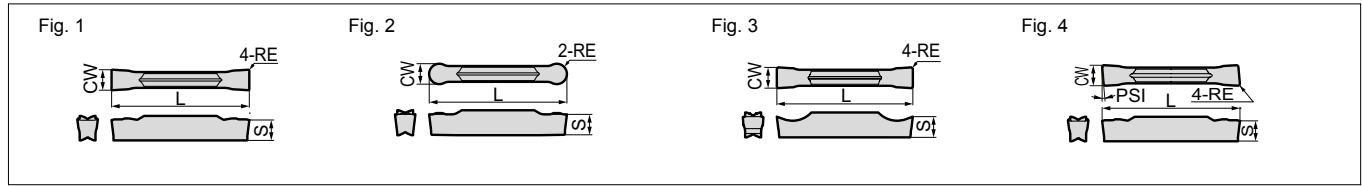

### Grooving / Traversing

Dimensions (mm)

Cat. No.	Insert								CW		RE	L	S	Fig.	
	AC8025P	AC8035P	AC830P	AC425K	AC5015S	AC5025S	AC520U	AC530U	T2500A	Cutting Width					Tolerance
GCM N3002 MG	●	●	●	○	●	●	●	●	—	3,0	±0,03	0,2	21,1	3,8	1
N3004 MG	●	●	●	○	●	●	●	●	—	±0,03	0,4	21,1	3,8		
N4002 MG	●	●	●	○	●	●	●	●	—	4,0	±0,03	0,2	26,4	4,0	
N4004 MG	●	●	●	○	●	●	●	●	—	±0,03	0,4	26,4	4,0		
N4008 MG	●	●	●	○	●	●	●	●	—	±0,03	0,8	26,4	4,0		
N5004 MG	●	●	●	○	●	●	●	●	—	5,0	±0,03	0,2	26,4	4,1	
N5008 MG	●	●	●	○	●	●	●	●	—	±0,03	0,8	26,4	4,1		
N6004 MG	●	●	●	○	●	●	●	●	—	6,0	±0,03	0,4	26,4	4,5	
N6008 MG	●	●	●	○	●	●	●	●	—	±0,03	0,8	26,4	4,5		
N7004 MG	●	●	●	○	●	●	●	●	—	7,0	±0,04	0,4	28,8	5,5	
N7008 MG	●	●	●	○	●	●	●	●	—	±0,04	0,8	28,8	5,5		
N8004 MG	●	●	●	○	●	●	●	●	—	8,0	±0,04	0,4	28,8	6,0	
N8008 MG	●	●	●	○	●	●	●	●	—	±0,04	0,8	28,8	6,0		
GCM N2002 ML	—	—	—	—	○	○	○	○	○	2,0	±0,03	0,2	21,1	3,6	1
N3002 ML	●	●	●	○	●	●	●	●	—	3,0	±0,03	0,2	21,1	3,8	
N3004 ML	●	●	●	○	●	●	●	●	—	±0,03	0,4	21,1	3,8		
N4002 ML	●	●	●	○	●	●	●	●	—	4,0	±0,03	0,2	26,4	4,0	
N4004 ML	●	●	●	○	●	●	●	●	—	±0,03	0,4	26,4	4,0		
N4008 ML	●	●	●	○	●	●	●	●	—	±0,03	0,8	26,4	4,0		
N5004 ML	●	●	●	○	●	●	●	●	—	5,0	±0,03	0,4	26,4	4,1	
N5008 ML	●	●	●	○	●	●	●	●	—	±0,03	0,8	26,4	4,1		
N6004 ML	●	●	●	○	●	●	●	●	—	6,0	±0,03	0,4	26,4	4,5	
N6008 ML	●	●	●	○	●	●	●	●	—	±0,03	0,8	26,4	4,5		
N7004 ML	●	●	●	○	●	●	●	●	—	7,0	±0,04	0,4	28,8	5,5	
N7008 ML	●	●	●	○	●	●	●	●	—	±0,04	0,8	28,8	5,5		
N8004 ML	●	●	●	○	●	●	●	●	—	8,0	±0,04	0,4	28,8	6,0	
N8008 ML	●	●	●	○	●	●	●	●	—	±0,04	0,8	28,8	6,0		

### Grooving / Cut-Off Machining

Dimensions (mm)

Cat. No.	Insert								CW		RE	L	S	Fig.
	AC8035P	AC830P	AC5015S	AC5025S	AC520U	AC530U	T2500A	Cutting Width	Tolerance					
GCM N2002 GG	●	●	●	●	●	●	●	—	2,0	±0,03	0,2	21,1	3,6	1
N3002 GG	●	●	●	●	○	○	○	—	3,0	±0,03	0,2	21,1	3,8	
N3004 GG	●	●	●	●	○	○	○	—	±0,03	0,4	21,1	3,8		
N4002 GG	●	●	●	●	○	○	○	—	4,0	±0,03	0,2	26,4	4,0	
N4004 GG	●	●	●	●	○	○	○	—	±0,03	0,4	26,4	4,0		
N5002 GG	●	●	●	●	○	○	○	—	5,0	±0,03	0,2	26,4	4,1	
N5004 GG	●	●	●	●	○	○	○	—	±0,03	0,4	26,4	4,1		
N6002 GG	●	●	●	●	○	○	○	—	6,0	±0,03	0,2	26,4	4,5	
N6004 GG	●	●	●	●	○	○	○	—	±0,03	0,4	26,4	4,5		
N7004 GG	●	○	●	●	○	○	○	—	7,0	±0,04	0,4	28,8	5,5	
N8004 GG	●	●	●	●	○	○	○	—	8,0	±0,04	0,4	28,8	6,0	
GCM N2002 GL	●	●	●	●	○	○	○	—	2,0	±0,03	0,2	21,1	3,6	1
N2004 GL	●	●	●	●	○	○	○	—	±0,03	0,4	21,1	3,6		
N3002 GL	●	●	●	●	○	○	○	—	3,0	±0,03	0,2	21,1	3,8	
N3004 GL	●	●	●	●	○	○	○	—	±0,03	0,4	21,1	3,8		
N4002 GL	●	●	●	●	○	○	○	—	4,0	±0,03	0,2	26,4	4,0	
N4004 GL	●	●	●	●	○	○	○	—	±0,03	0,4	26,4	4,0		
N5002 GL	●	●	●	●	○	○	○	—	5,0	±0,03	0,2	26,4	4,1	
N5004 GL	●	●	●	●	○	○	○	—	±0,03	0,4	26,4	4,1		
N6002 GL	●	●	●	●	○	○	○	—	6,0	±0,03	0,2	26,4	4,5	
N6004 GL	●	●	●	●	○	○	○	—	±0,03	0,4	26,4	4,5		
N7004 GL	●	○	●	●	○	○	○	—	7,0	±0,04	0,4	28,8	5,5	
N8004 GL	●	○	●	●	○	○	○	—	8,0	±0,04	0,4	28,8	6,0	
GCM N125005 GF	—	—	—	—	—	—	—	—	1,25	±0,03	0,05	17,4	3,2	1
N150005 GF	—	—	—	—	—	—	—	—	1,5	±0,03	0,05	17,4	3,7	
GCM N2002 GF	—	—	—	●	○	○	○	○	2,0	±0,03	0,2	21,1	3,6	1
N2004 GF	—	—	—	●	○	○	○	○	±0,03	0,4	21,1	3,6		
N3002 GF	●	●	●	●	○	○	○	—	3,0	±0,03	0,2	21,1	3,8	
N3004 GF	●	●	●	●	○	○	○	—	±0,03	0,4	21,1	3,8		
N4002 GF	●	●	●	●	○	○	○	—	4,0	±0,03	0,2	26,4	4,0	
N4004 GF	●	●	●	●	○	○	○	—	±0,03	0,4	26,4	4,0		
N5002 GF	●	●	●	●	○	○	○	—	5,0	±0,03	0,2	26,4	4,1	
N5004 GF	●	●	●	●	○	○	○	—	±0,03	0,4	26,4	4,1		
N6002 GF	●	●	●	●	○	○	○	—	6,0	±0,03	0,2	26,4	4,5	
N6004 GF	●	●	●	●	○	○	○	—	±0,03	0,4	26,4	4,5		
N7002 GF	●	●	●	●	○	○	○	—	7,0	±0,04	0,2	28,8	5,5	
N7004 GF	●	●	●	●	○	○	○	—	±0,04	0,4	28,8	5,5		
N8002 GF	●	●	●	●	○	○	○	—	8,0	±0,04	0,2	28,8	6,0	
N8004 GF	●	●	●	●	○	○	○	—	±0,04	0,4	28,8	6,0		

### External Profiling / External Radius Grooving

Dimensions (mm)

Cat. No.	Insert								CW		RE	L	S	Fig.	
	AC8025P	AC8035P	AC830P	AC425K	AC5015S	AC5025S	AC520U	AC530U	T2500A	Cutting Width					Tolerance
GCM N3015 RG	●	●	●	○	●	●	●	●	—	3,0	±0,03	1,5	21,1	3,8	2
N4020 RG	●	●	●	○	●	●	●	●	—	4,0	±0,03	2,0	26,4	4,0	
N5025 RG	●	●	●	○	●	●	●	●	—	5,0	±0,03	2,5	27,2	4,1	
N6030 RG	●	●	●	○	●	●	●	●	—	6,0	±0,03	3,0	27,5	4,5	
N7035 RG	●	●	●	○	●	●	●	●	—	7,0	±0,04	3,5	29,1	5,5	
N8040 RG	●	●	●	○	●	●	●	●	—	8,0	±0,04	4,0	29,3	6,0	

### Cut-Off Machining (Handed Edge)

Dimensions (mm)

Cat. No.	Insert							Angle	CW		RE	L	S	Fig.
	AC8035P	AC830P	AC5015S	AC5025S	AC520U	AC530U	AC1030U		Cutting Width	Tolerance				
GCM R2002 CG 05	●	●	●	●	○	○	—	5°	2,0	±0,03	0,2	21,1	3,6	4
L2002 CG 05	●	●	●	●	○	○	—	5°	2,0	±0,03	0,2	21,1	3,6	
GCM R3002 CG 05	●	●	●	●	○	○	—	5°	3,0	±0,03	0,2	21,3	3,8	
L3002 CG 05	●	●	●	●	○	○	—	5°	3,0	±0,03	0,2	21,3	3,8	
GCM R4002 CG 05	●	●	●	●	○	○	—	5°	4,0	±0,04	0,2	26,7	4,0	
L4002 CG 05	●	●	●	●	○	○	—	5°	4,0	±0,04	0,2	26,7	4,0	
GCM R20003 CF 10	—	—	●	●	—	—	●	10°	2,0	±0,08	0,03	22,4	3,6	4
L20003 CF 10	—	—	●	●	—	—	●	10°	2,0	±0,08	0,03	22,4	3,6	
GCM R30003 CF 10	—	—	●	●	—	—	●	10°	3,0	±0,08	0,03	22,4	3,8	
L30003 CF 10	—	—	●	●	—	—	●	10°	3,0	±0,08	0,03	22,4	3,8	
GCM R20003 CF 15	—	—	●	●	—	—	●	15°	2,0	±0,08	0,03	22,4	3,6	
L20003 CF 15	—	—	●	●	—	—	●	15°	2,0	±0,08	0,03	22,4	3,6	
GCM R30003 CF 15	—	—	●	●	—	—	●	15°	3,0	±0,08	0,03	22,4	3,8	
L30003 CF 15	—	—	●	●	—	—	●	15°	3,0	±0,08	0,03	22,4	3,8	

GCM R: Right hand    GCM L: Left hand  
Combine the insert with a holder such that the width of cut (CW) matches.

### Profiling / Radius Grooving / Necking

Dimensions (mm)

Cat. No.	H	Insert							CW		RE	L	S	Fig.	
		AC8025P	AC8035P	AC830P	AC425K	AC5015S	AC5025S	AC520U	AC530U	T2500A					Cutting Width
GCM N2010 RN	○	—	—	—	—	—	—	—	—	2,0	±0,03	1,0	21,7	3,6	2
N3015 RN	●	●	●	○	●	●	●	●	—	3,0	±0,03	1,5	22,6	3,8	
N4020 RN	●	●	●	○	●	●	●	●	—	4,0	±0,03	2,0	28,2	4,0	
N5025 RN	●	●	●	○	●	●	●	●	—	5,0	±0,03	2,5	28,3	4,1	
N6030 RN	●	●	●	○	●	●	●	●	—	6,0	±0,03	3,0	28,3	4,5	

### Non-Ferrous Metals

Dimensions (mm)

Cat. No.	H	Insert							CW		RE	L	S	Fig.
		AC8025P	AC8035P	AC830P	AC425K	AC5015S	AC5025S	AC520U	AC530U	T2500A				
GCG N2002 GA	○	—	—	—	—	—	—	—	—	2,0	±0,025	0,2	21,1	3,6</

# Grooving Tool Holders

## GNDM-JE Type

## Holder with Internal Coolant

### External Multi-Purpose Type (Grooving, Turning, Profiling)

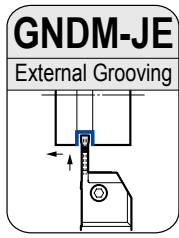

Internal Coolant



Use for multi-purpose or profiling insert for turning (wide grooves).

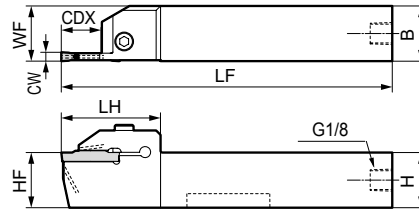

Above figures show right hand tools.

### Spare Parts

Cap Screw	Plug and Sealing	Grub Screw*	Spanner	
BX0520	6,0	XP02-E	BT0505-E	LH040

### Holders

Cat. No.	Stock		Dimensions (mm)						Grooving Width (mm)	Max. Groov. Depth (mm)	Max. Cutt-Off Dia (mm)	Applicable Insert	Cap Screw	Plug and Sealing	Grub Screw*	Spanner	
	R	L	H	B	LF	WF	HF	LH									CW
GNDM R/L 2020 X 210 JE	●	●	20	20	100	20	20	33,6	2,00	10	20	GC □ 2000-□□	BX0520	6,0	XP02-E	BT0505-E	LH040
GNDM R/L 2020 X 312 JE	●	●	20	20	100	20	20	36,6	3,00	12	24	GC □ 3000-□□					
GNDM R/L 2020 X 418 JE	●	●	20	20	110	20	20	45,0	4,00	18	36	GC □ 4000-□□					
GNDM R/L 2020 X 518 JE	●	●	20	20	110	20	20	45,0	5,00	18	36	GC □ N5000-□□					
GNDM R/L 2020 X 618 JE	●	●	20	20	110	20	20	45,0	6,00	18	36	GC □ N6000-□□					
GNDM R/L 2525 X 210 JE	●	●	25	25	100	25	25	33,6	2,00	10	20	GC □ 2000-□□					
GNDM R/L 2525 X 312 JE	●	●	25	25	100	25	25	36,6	3,00	12	24	GC □ 3000-□□					
GNDM R/L 2525 X 418 JE	●	●	25	25	110	25	25	45,0	4,00	18	36	GC □ 4000-□□					
GNDM R/L 2525 X 518 JE	●	●	25	25	110	25	25	45,0	5,00	18	36	GC □ N5000-□□					
GNDM R/L 2525 X 618 JE	●	●	25	25	110	25	25	45,0	6,00	18	36	GC □ N6000-□□					

Select holders and inserts with the same grooving width (CW).

\*Grub screws are sold separately (M5x5)

### Parts (Hose)

Fig. 1

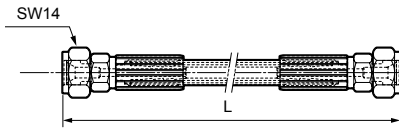

Cat. No.	Stock	L (mm)	Srew Standard	Srew Standard	Fig.
J-HOSE-G1/8-G1/8-200-E	●	200	G1/8	G1/8	1
J-HOSE-G1/8-G1/8-300-E	●	300	G1/8	G1/8	1

Hoses are sold separately.

### Parts (Connector)

Fig. 1

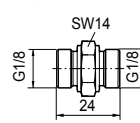

Fig. 2

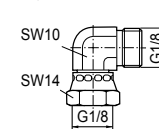
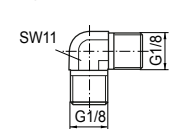

Fig. 3



Cat. No.	Stock	Srew Standard	Srew Standard	Fig.
J-G1/8-G1/8-00-E	●	G1/8	G1/8	1
J-G1/8-G1/8F-90-E	●	G1/8	G1/8	2
J-G1/8-G1/8-90-E	●	G1/8	G1/8	3

Connectors are sold separately.

# Grooving Tool Holders GNDM-JE Type

## Inserts for GNDM-JE

Coated Carbide    Cermet    Carbide

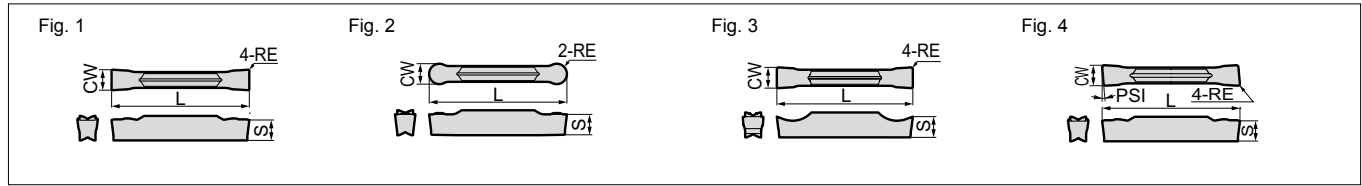

### Grooving / Traversing

Dimensions (mm)

Cat. No.	AC8025P	AC8035P	AC830P	AC425K	AC5015S	AC5025S	AC520U	AC530U	T2500A	CW		RE	L	S	Fig.
										Cutting Width	Tolerance				
GCM N3002 MG	●	●	●	○	●	●	○	●	—	3,0	±0,03	0,2	21,1	3,8	1
N3004 MG	●	●	●	○	●	●	○	●	—	±0,03	0,4	21,1	3,8		
N4002 MG	●	●	●	○	●	●	○	●	—	±0,03	0,2	26,4	4,0		
N4004 MG	●	●	●	○	●	●	○	●	—	4,0	±0,03	0,4	26,4	4,0	
N4008 MG	●	●	●	○	●	●	○	●	—	±0,03	0,8	26,4	4,0		
N5004 MG	●	●	●	○	●	●	○	●	—	5,0	±0,03	0,4	26,4	4,1	
N5008 MG	●	●	●	○	●	●	○	●	—	±0,03	0,8	26,4	4,1		
N6004 MG	●	●	●	○	●	●	○	●	—	6,0	±0,03	0,4	26,4	4,5	
N6008 MG	●	●	●	○	●	●	○	●	—	±0,03	0,8	26,4	4,5		
GCM N2002 ML	—	—	—	—	●	●	○	●	—	2,0	±0,03	0,2	21,1	3,6	1
N3002 ML	●	●	●	○	●	●	○	●	—	3,0	±0,03	0,2	21,1	3,8	
N3004 ML	●	●	●	○	●	●	○	●	—	±0,03	0,4	21,1	3,8		
N4002 ML	●	●	●	○	●	●	○	●	—	±0,03	0,2	26,4	4,0		
N4004 ML	●	●	●	○	●	●	○	●	—	4,0	±0,03	0,4	26,4	4,0	
N4008 ML	●	●	●	○	●	●	○	●	—	±0,03	0,8	26,4	4,0		
N5004 ML	●	●	●	○	●	●	○	●	—	5,0	±0,03	0,4	26,4	4,1	
N5008 ML	●	●	●	○	●	●	○	●	—	±0,03	0,8	26,4	4,1		
N6004 ML	●	●	●	○	●	●	○	●	—	6,0	±0,03	0,4	26,4	4,5	
N6008 ML	●	●	●	○	●	●	○	●	—	±0,03	0,8	26,4	4,5		

### Grooving / Cut-Off Machining

Dimensions (mm)

Cat. No.	AC8035P	AC830P	AC5015S	AC5025S	AC520U	AC530U	T2500A	CW		RE	L	S	Fig.
								Cutting Width	Tolerance				
GCM N2002 GG	●	●	●	●	○	●	—	2,0	±0,03	0,2	21,1	3,6	1
N3002 GG	●	●	●	●	○	●	—	3,0	±0,03	0,2	21,1	3,8	
N3004 GG	●	●	●	●	○	●	—	±0,03	0,4	21,1	3,8		
N4002 GG	●	●	●	●	○	●	—	4,0	±0,03	0,2	26,4	4,0	
N4004 GG	●	●	●	●	○	●	—	±0,03	0,4	26,4	4,0		
N5002 GG	●	●	●	●	○	●	—	5,0	±0,03	0,2	26,4	4,1	
N5004 GG	●	●	●	●	○	●	—	±0,03	0,4	26,4	4,1		
N6002 GG	●	●	●	●	○	●	—	6,0	±0,03	0,2	26,4	4,5	
N6004 GG	●	●	●	●	○	●	—	±0,03	0,4	26,4	4,5		
GCM N2002 GL	●	●	●	●	○	●	—	2,0	±0,03	0,2	21,1	3,6	1
N2004 GL	●	●	●	●	○	●	—	±0,03	0,4	21,1	3,6		
N3002 GL	●	●	●	●	○	●	—	3,0	±0,03	0,2	21,1	3,8	
N3004 GL	●	●	●	●	○	●	—	±0,03	0,4	21,1	3,8		
N4002 GL	●	●	●	●	○	●	—	4,0	±0,03	0,2	26,4	4,0	
N4004 GL	●	●	●	●	○	●	—	±0,03	0,4	26,4	4,0		
N5002 GL	●	●	●	●	○	●	—	5,0	±0,03	0,2	26,4	4,1	
N5004 GL	●	●	●	●	○	●	—	±0,03	0,4	26,4	4,1		
N6002 GL	●	●	●	●	○	●	—	6,0	±0,03	0,2	26,4	4,5	
N6004 GL	●	●	●	●	○	●	—	±0,03	0,4	26,4	4,5		
GCM N2002 GF	—	—	●	●	●	○	—	2,0	±0,03	0,2	21,1	3,6	1
N2004 GF	—	—	●	●	●	○	—	±0,03	0,4	21,1	3,6		
N3002 GF	●	●	●	●	○	●	—	3,0	±0,03	0,2	21,1	3,8	
N3004 GF	●	●	●	●	○	●	—	±0,03	0,4	21,1	3,8		
N4002 GF	●	●	●	●	○	●	—	4,0	±0,03	0,2	26,4	4,0	
N4004 GF	●	●	●	●	○	●	—	±0,03	0,4	26,4	4,0		
N5002 GF	●	●	●	●	○	●	—	5,0	±0,03	0,2	26,4	4,1	
N5004 GF	●	●	●	●	○	●	—	±0,03	0,4	26,4	4,1		
N6002 GF	●	●	●	●	○	●	—	6,0	±0,03	0,2	26,4	4,5	
N6004 GF	●	●	●	●	○	●	—	±0,03	0,4	26,4	4,5		

### External Profiling / External Radius Grooving

Dimensions (mm)

Cat. No.	AC8025P	AC8035P	AC830P	AC425K	AC5015S	AC5025S	AC520U	AC530U	T2500A	CW		RE	L	S	Fig.
										Cutting Width	Tolerance				
GCM N3015 RG	●	●	●	●	●	●	○	●	○	3,0	±0,03	1,5	21,1	3,8	2
N4020 RG	●	●	●	●	●	●	○	●	○	4,0	±0,03	2,0	26,4	4,0	
N5025 RG	●	●	●	●	●	●	○	●	○	5,0	±0,03	2,5	27,2	4,1	
N6030 RG	●	●	●	●	●	●	○	●	○	6,0	±0,03	3,0	27,5	4,5	

### Cut-Off Machining (Handed Edge)

Dimensions (mm)

Cat. No.	AC8035P	AC830P	AC5015S	AC5025S	AC520U	AC530U	AC1030U	CW		RE	L	S	Fig.	
								Cutting Width	Tolerance					
GCM R2002 CG 05	●	●	●	●	○	●	—	5°	2,0	±0,03	0,2	21,1	3,6	4
L2002 CG 05	●	●	●	●	○	●	—	5°	2,0	±0,03	0,2	21,1	3,6	
GCM R3002 CG 05	●	●	●	●	○	●	—	5°	3,0	±0,03	0,2	21,3	3,8	
L3002 CG 05	●	●	●	●	○	●	—	5°	3,0	±0,03	0,2	21,3	3,8	
GCM R4002 CG 05	●	●	●	●	○	●	—	5°	4,0	±0,04	0,2	26,7	4,0	
L4002 CG 05	●	●	●	●	○	●	—	5°	4,0	±0,04	0,2	26,7	4,0	
GCM R2003 CF 10	—	—	●	●	—	—	●	10°	2,0	±0,08	0,03	22,4	3,6	
L2003 CF 10	—	—	●	●	—	—	●	10°	2,0	±0,08	0,03	22,4	3,6	
GCM R3003 CF 10	—	—	●	●	—	—	●	10°	3,0	±0,08	0,03	22,4	3,8	
L3003 CF 10	—	—	●	●	—	—	●	10°	3,0	±0,08	0,03	22,4	3,8	
GCM R2003 CF 15	—	—	●	●	—	—	●	15°	2,0	±0,08	0,03	22,4	3,6	4
L2003 CF 15	—	—	●	●	—	—	●	15°	2,0	±0,08	0,03	22,4	3,6	
GCM R3003 CF 15	—	—	●	●	—	—	●	15°	3,0	±0,08	0,03	22,4	3,8	
L3003 CF 15	—	—	●	●	—	—	●	15°	3,0	±0,08	0,03	22,4	3,8	

GCM R: Right hand

GCM L: Left hand

Combine the insert with a holder such that the width of cut (CW) matches.

### Profiling / Radius Grooving / Necking

Dimensions (mm)

Cat. No.	AC8025P	AC8035P	AC830P	AC425K	AC5015S	AC5025S	AC520U	AC530U	T2500A	CW		RE	L	S	Fig.
										Cutting Width	Tolerance				
GCM N2010 RN	—	—	—	—	●	●	○	●	—	2,0	±0,03	1,0	21,7	3,6	2
N3015 RN	●	●	●	○	●	●	○	●	—	3,0	±0,03	1,5	22,6	3,8	
N4020 RN	●	●	●	○	●	●	○	●	—	4,0	±0,03	2,0	28,2	4,0	
N5025 RN	●	●	●	○	●	●	○	●	—	5,0	±0,03	2,5	28,3	4,1	
N6030 RN	●	●	●	○	●	●	○	●	—	6,0	±0,03	3,0	28,3	4,5	

### Non-Ferrous Metals

Dimensions (mm)

Cat. No.	H1	CW		RE	L	S	Fig.
		Cutting Width	Tolerance				
GCG N2002 GA	○	2,0	±0,025	0,2	21,1	3,6	3
N3002 GA	○	3,0	±0,025	0,2	21,1	3,8	
N4004 GA	○	4,0	±0,025	0,4	26,4	4,0	
N5004 GA	○	5,0	±0,025	0,4	26,4	4,1	
N6004 GA	○	6,0	±0,025	0,4	26,4	4,5	

# Grooving Tool Holders

## GNDL / GNDLS Type

### External Deep Grooving and Cut-Off

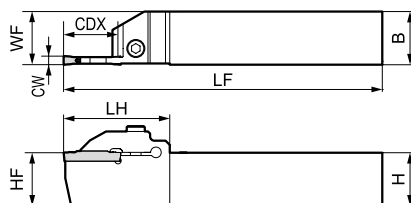
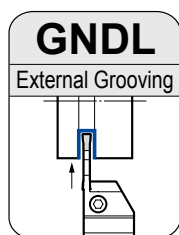

Above figures show right hand tools.

### Spare Parts

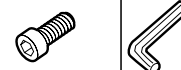

### Holders

Cat. No.	Stock		Dimensions (mm)						Grooving Width (mm)	Max. Groov. Depth (mm)	Max. Cutt-Off Dia (mm)	Applicable Insert	Cap Screw	N·m	Spanner
	R	L	H	B	LF	WF	HF	LH							
GNDL R/L 2020 K 1.2516	●	●	20	20	125	20	20	38,0	1,25	16	32	GCM N125005 GF	BX0520	5,0	LH040
GNDL R/L 2020 K 1.516	●	●	20	20	125	20	20	38,0	1,50	16	32	GCM N150005 GF			
GNDL R/L 2020 K 220	●	●	20	20	125	20	20	44,5	2,00	20	40	GCM □200○-□□			
GNDL R/L 2020 K 320	●	●	20	20	125	20	20	44,5	3,00	20(18)	40	GCM □300○-□□			
GNDL R/L 2020 K 425	●	●	20	20	125	20	20	50,0	4,00	25(23)	50	GCM □400○-□□			
GNDL R/L 2020 K 525	●	●	20	20	125	20	20	50,0	5,00	25(23)	50	GCM N500○-□□			
GNDL R/L 2020 K 625	●	●	20	20	125	20	20	50,0	6,00	25(23)	50	GCM N600○-□□			
GNDL R/L 2525 M 1.2516	●	●	25	25	150	25	25	40,0	1,25	16	32	GCM N125005 GF			
GNDL R/L 2525 M 1.516	●	●	25	25	150	25	25	40,0	1,50	16	32	GCM N150005 GF			
GNDL R/L 2525 M 220	●	●	25	25	150	25	25	44,5	2,00	20	40	GCM □200○-□□			
GNDL R/L 2525 M 320	●	●	25	25	150	25	25	44,5	3,00	20(18)	40	GCM □300○-□□			
GNDL R/L 2525 M 425	●	●	25	25	150	25	25	50,0	4,00	25(23)	50	GCM □400○-□□			
GNDL R/L 2525 M 525	●	●	25	25	150	25	25	50,0	5,00	25(23)	50	GCM N500○-□□			
GNDL R/L 2525 M 625	●	●	25	25	150	25	25	50,0	6,00	25(23)	50	GCM N600○-□□			
GNDL R/L 3225 P 320			32	25	170	25	32	44,5	3,00	20(18)	40	GCM □300○-□□	BX0520	6,0	LH050
GNDL R/L 3225 P 425			32	25	170	25	32	50,0	4,00	25(23)	50	GCM □400○-□□			
GNDL R/L 3225 P 525			32	25	170	25	32	50,0	5,00	25(23)	50	GCM N500○-□□			
GNDL R/L 3225 P 625			32	25	170	25	32	50,0	6,00	25(23)	50	GCM N600○-□□			
GNDL R/L 3225 P 725			32	25	170	25	32	50,0	7,00	25(23)	50	GCM N700○-□□			
GNDL R/L 3225 P 825			32	25	170	25	32	50,0	8,00	25(23)	50	GCM N800○-□□			
GNDL R/L 3232 P 320	●	●	32	32	170	32	32	44,5	3,00	20(18)	40	GCM □300○-□□			
GNDL R/L 3232 P 425	●	●	32	32	170	32	32	50,0	4,00	25(23)	50	GCM □400○-□□			
GNDL R/L 3232 P 525	●	●	32	32	170	32	32	50,0	5,00	25(23)	50	GCM N500○-□□			
GNDL R/L 3232 P 625	●	●	32	32	170	32	32	50,0	6,00	25(23)	50	GCM N600○-□□			
GNDL R/L 3232 P 725	●	●	32	32	170	32	32	50,0	7,00	25(23)	50	GCM N700○-□□			
GNDL R/L 3232 P 825	●	●	32	32	170	32	32	50,0	8,00	25(23)	50	GCM N800○-□□			

Select holders and inserts with the same grooving width (CW). Dimensions in parentheses are for applications that use copying inserts (RG type breakers).

### External L-Styled (Side Cut) Grooving

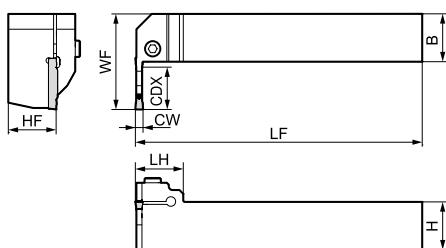
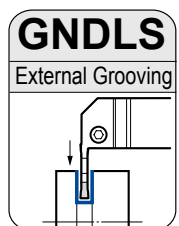

Above figures show right hand tools.

### Spare Parts

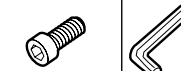

### Holders

Cat. No.	Stock		Dimensions (mm)						Grooving Width (mm)	Max. Groov. Depth (mm)	Applicable Insert	Cap Screw	N·m	Spanner
	R	L	H	B	LF	WF	HF	LH						
GNDLS R/L 2020 K 216	●	●	20	20	125	38	20	25	2,0	16	GCM □200○-□□	BX0520	5,0	LH040
GNDLS R/L 2020 K 316	○	●	20	20	125	38	20	25	3,0	16	GCM □300○-□□			
GNDLS R/L 2525 M 218	●	●	25	25	150	45	25	25	2,0	18	GCM □200○-□□			
GNDLS R/L 2525 M 318	●	●	25	25	150	45	25	25	3,0	18	GCM □300○-□□			
GNDLS R/L 2525 M 423	●	●	25	25	150	50	25	25	4,0	23	GCM □400○-□□			
GNDLS R/L 2525 M 523	○	○	25	25	150	50	25	25	5,0	23	GCM N500○-□□			
GNDLS R/L 2525 M 623	●	○	25	25	150	50	25	25	6,0	23	GCM N600○-□□			

Select holders and inserts with the same grooving width (CW).

● Euro stock

○ Japan stock





# Grooving Tool Holders

## GNDL-JE Type

### Holder with Internal Coolant

#### External Deep Grooving and Cut-Off

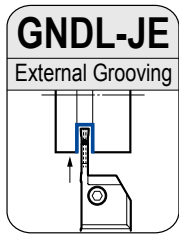

Internal Coolant

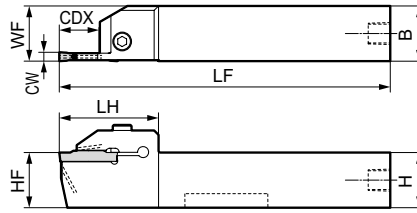

Above figures show right hand tools.

#### Spare Parts

Cap Screw	Plug and Sealing	Grub Screw*	Spanner	
BX0520	6,0	XP02-E	BT0505-E	LH040

#### Holders

Cat. No.	Stock		Dimensions (mm)						Grooving Width (mm)	Max. Groov. Depth (mm)	Max. Cutt-Off Dia (mm)	Applicable Insert	Cap Screw	Plug and Sealing	Grub Screw*	Spanner	
	R	L	H	B	LF	WF	HF	LH									CW
GNDL R/L 2020 X 220 JE	●	●	20	20	110	20	20	44,5	2,00	20	40	GC □ 2000-□□	BX0520	6,0	XP02-E	BT0505-E	LH040
GNDL R/L 2020 X 320 JE	●	●	20	20	110	20	20	44,5	3,00	20	40	GC □ 3000-□□					
GNDL R/L 2020 X 425 JE	●	●	20	20	115	20	20	50,0	4,00	25	50	GC □ 4000-□□					
GNDL R/L 2020 X 525 JE	●	●	20	20	115	20	20	50,0	5,00	25	50	GC □ N5000-□□					
GNDL R/L 2020 X 625 JE	●	●	20	20	115	20	20	50,0	6,00	25	50	GC □ N6000-□□					
GNDL R/L 2525 X 220 JE	●	●	25	25	110	25	25	44,5	2,00	20	40	GC □ 2000-□□					
GNDL R/L 2525 X 320 JE	●	●	25	25	110	25	25	44,5	3,00	20	40	GC □ 3000-□□					
GNDL R/L 2525 X 425 JE	●	●	25	25	115	25	25	50,0	4,00	25	50	GC □ 4000-□□					
GNDL R/L 2525 X 525 JE	●	●	25	25	115	25	25	50,0	5,00	25	50	GC □ N5000-□□					
GNDL R/L 2525 X 625 JE	●	●	25	25	115	25	25	50,0	6,00	25	50	GC □ N6000-□□					

Select holders and inserts with the same grooving width (CW).

\*Grub screws are sold separately (M5x5)

#### Parts (Hose)

Fig. 1

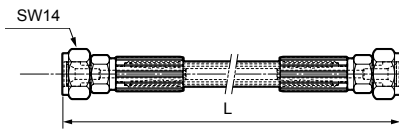

Cat. No.	Stock	L (mm)	Srew Standard	Srew Standard	Fig.
J-HOSE-G1/8-G1/8-200-E	●	200	G1/8	G1/8	1
J-HOSE-G1/8-G1/8-300-E	●	300	G1/8	G1/8	1

Hoses are sold separately.

#### Parts (Connector)

Fig. 1

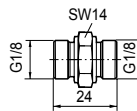

Fig. 2

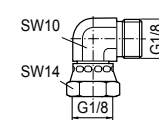
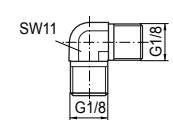

Fig. 3



Cat. No.	Stock	Srew Standard	Srew Standard	Fig.
J-G1/8-G1/8-00-E	●	G1/8	G1/8	1
J-G1/8-G1/8F-90-E	●	G1/8	G1/8	2
J-G1/8-G1/8-90-E	●	G1/8	G1/8	3

Connectors are sold separately.

# Grooving Tool Holders GNDL-JE Type

## Inserts for GNDL-JE

Coated Carbide    Cermet    Carbide

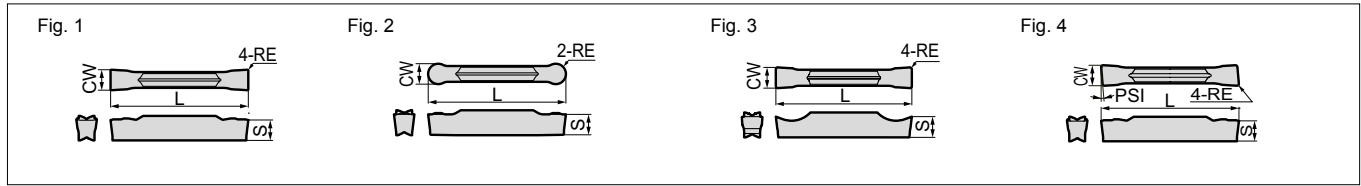

### Grooving / Traversing

Dimensions (mm)

Cat. No.	AC8025P	AC8035P	AC830P	AC425K	AC5015S	AC5025S	AC520U	AC530U	T2500A	CW		RE	L	S	Fig.
										Cutting Width	Tolerance				
GCM N3002 MG	●	●	●	○	●	●	○	●	—	3,0	±0,03	0,2	21,1	3,8	1
N3004 MG	●	●	●	○	●	●	○	●	—	±0,03	0,4	21,1	3,8		
N4002 MG	●	●	●	○	●	●	○	●	—	±0,03	0,2	26,4	4,0		
N4004 MG	●	●	●	○	●	●	○	●	—	4,0	±0,03	0,4	26,4	4,0	
N4008 MG	●	●	●	○	●	●	○	●	—	±0,03	0,8	26,4	4,0		
N5004 MG	●	●	●	○	●	●	○	●	—	5,0	±0,03	0,4	26,4	4,1	
N5008 MG	●	●	●	○	●	●	○	●	—	±0,03	0,8	26,4	4,1		
N6004 MG	●	●	●	○	●	●	○	●	—	6,0	±0,03	0,4	26,4	4,5	
N6008 MG	●	●	●	○	●	●	○	●	—	±0,03	0,8	26,4	4,5		
GCM N2002 ML	—	—	—	—	—	—	—	—	—	2,0	±0,03	0,2	21,1	3,6	1
N3002 ML	●	●	●	○	●	●	○	●	—	±0,03	0,2	21,1	3,8		
N3004 ML	●	●	●	○	●	●	○	●	—	±0,03	0,4	21,1	3,8		
N4002 ML	●	●	●	○	●	●	○	●	—	±0,03	0,2	26,4	4,0		
N4004 ML	●	●	●	○	●	●	○	●	—	4,0	±0,03	0,4	26,4	4,0	
N4008 ML	●	●	●	○	●	●	○	●	—	±0,03	0,8	26,4	4,0		
N5004 ML	●	●	●	○	●	●	○	●	—	5,0	±0,03	0,4	26,4	4,1	
N5008 ML	●	●	●	○	●	●	○	●	—	±0,03	0,8	26,4	4,1		
N6004 ML	●	●	●	○	●	●	○	●	—	6,0	±0,03	0,4	26,4	4,5	
N6008 ML	●	●	●	○	●	●	○	●	—	±0,03	0,8	26,4	4,5		

### Grooving / Cut-Off Machining

Dimensions (mm)

Cat. No.	AC8035P	AC830P	AC5015S	AC5025S	AC520U	AC530U	T2500A	CW		RE	L	S	Fig.
								Cutting Width	Tolerance				
GCM N2002 GG	●	●	●	●	●	●	—	2,0	±0,03	0,2	21,1	3,6	1
N3002 GG	●	●	●	●	●	●	—	±0,03	0,2	21,1	3,8		
N3004 GG	●	●	●	○	●	●	—	3,0	±0,03	0,4	21,1	3,8	
N4002 GG	●	●	●	○	●	●	—	4,0	±0,03	0,2	26,4	4,0	
N4004 GG	●	●	●	○	●	●	—	±0,03	0,4	26,4	4,0		
N5002 GG	●	●	●	○	●	●	—	5,0	±0,03	0,2	26,4	4,1	
N5004 GG	●	●	●	○	●	●	—	±0,03	0,4	26,4	4,1		
N6002 GG	●	●	●	○	●	●	—	6,0	±0,03	0,2	26,4	4,5	
N6004 GG	●	●	●	○	●	●	—	±0,03	0,4	26,4	4,5		
GCM N2002 GL	●	●	●	○	●	—	—	2,0	±0,03	0,2	21,1	3,6	1
N2004 GL	●	●	●	○	●	—	—	±0,03	0,4	21,1	3,6		
N3002 GL	●	●	●	○	●	—	—	3,0	±0,03	0,2	21,1	3,8	
N3004 GL	●	●	●	○	●	—	—	±0,03	0,4	21,1	3,8		
N4002 GL	●	●	●	○	●	—	—	4,0	±0,03	0,2	26,4	4,0	
N4004 GL	●	●	●	○	●	—	—	±0,03	0,4	26,4	4,0		
N5002 GL	●	●	●	○	●	—	—	5,0	±0,03	0,2	26,4	4,1	
N5004 GL	●	●	●	○	●	—	—	±0,03	0,4	26,4	4,1		
N6002 GL	●	●	●	○	●	—	—	6,0	±0,03	0,2	26,4	4,5	
N6004 GL	●	●	●	○	●	—	—	±0,03	0,4	26,4	4,5		
GCM N2002 GF	—	—	●	●	●	○	—	2,0	±0,03	0,2	21,1	3,6	1
N2004 GF	—	—	●	●	●	○	—	±0,03	0,4	21,1	3,6		
N3002 GF	●	●	●	○	●	—	—	3,0	±0,03	0,2	21,1	3,8	
N3004 GF	●	●	●	○	●	—	—	±0,03	0,4	21,1	3,8		
N4002 GF	●	●	●	○	●	—	—	4,0	±0,03	0,2	26,4	4,0	
N4004 GF	●	●	●	○	●	—	—	±0,03	0,4	26,4	4,0		
N5002 GF	●	●	●	○	●	—	—	5,0	±0,03	0,2	26,4	4,1	
N5004 GF	●	●	●	○	●	—	—	±0,03	0,4	26,4	4,1		
N6002 GF	●	●	●	○	●	—	—	6,0	±0,03	0,2	26,4	4,5	
N6004 GF	●	●	●	○	●	—	—	±0,03	0,4	26,4	4,5		

### External Profiling / External Radius Grooving

Dimensions (mm)

Cat. No.	AC8025P	AC8035P	AC830P	AC425K	AC5015S	AC5025S	AC520U	AC530U	T2500A	CW		RE	L	S	Fig.
										Cutting Width	Tolerance				
GCM N3015 RG	●	●	●	○	●	●	○	●	—	3,0	±0,03	1,5	21,1	3,8	2
N4020 RG	●	●	●	○	●	●	○	●	—	4,0	±0,03	2,0	26,4	4,0	
N5025 RG	●	●	●	○	●	●	○	●	—	5,0	±0,03	2,5	27,2	4,1	
N6030 RG	●	●	●	○	●	●	○	●	—	6,0	±0,03	3,0	27,5	4,5	

### Cut-Off Machining (Handed Edge)

Dimensions (mm)

Cat. No.	AC8035P	AC830P	AC5015S	AC5025S	AC520U	AC530U	AC1030U	CW		RE	L	S	Fig.	
								Cutting Width	Tolerance					
GCM R2002 CG 05	●	●	●	○	●	—	—	5°	2,0	±0,03	0,2	21,1	3,6	4
L2002 CG 05	●	●	●	○	●	—	—	5°	2,0	±0,03	0,2	21,1	3,6	
GCM R3002 CG 05	●	●	●	○	●	—	—	5°	3,0	±0,03	0,2	21,3	3,8	
L3002 CG 05	●	●	●	○	●	—	—	5°	3,0	±0,03	0,2	21,3	3,8	
GCM R4002 CG 05	●	●	●	○	●	—	—	5°	4,0	±0,04	0,2	26,7	4,0	
L4002 CG 05	●	●	●	○	●	—	—	5°	4,0	±0,04	0,2	26,7	4,0	
GCM R2003 CF 10	—	—	●	●	—	—	—	10°	2,0	±0,08	0,03	22,4	3,6	
L2003 CF 10	—	—	●	●	—	—	—	10°	2,0	±0,08	0,03	22,4	3,6	
GCM R3003 CF 10	—	—	●	●	—	—	—	10°	3,0	±0,08	0,03	22,4	3,8	
L3003 CF 10	—	—	●	●	—	—	—	10°	3,0	±0,08	0,03	22,4	3,8	
GCM R2003 CF 15	—	—	●	●	—	—	—	15°	2,0	±0,08	0,03	22,4	3,6	4
L2003 CF 15	—	—	●	●	—	—	—	15°	2,0	±0,08	0,03	22,4	3,6	
GCM R3003 CF 15	—	—	●	●	—	—	—	15°	3,0	±0,08	0,03	22,4	3,8	
L3003 CF 15	—	—	●	●	—	—	—	15°	3,0	±0,08	0,03	22,4	3,8	

GCM R: Right hand

GCM L: Left hand

Combine the insert with a holder such that the width of cut (CW) matches.

### Profiling / Radius Grooving / Necking

Dimensions (mm)

Cat. No.	AC8025P	AC8035P	AC830P	AC425K	AC5015S	AC5025S	AC520U	AC530U	T2500A	CW		RE	L	S	Fig.
										Cutting Width	Tolerance				
GCM N2010 RN	—	—	—	—	—	—	—	—	—	2,0	±0,03	1,0	21,7	3,6	2
N3015 RN	●	●	●	○	●	●	○	●	—	3,0	±0,03	1,5	22,6	3,8	
N4020 RN	●	●	●	○	●	●	○	●	—	4,0	±0,03	2,0	28,2	4,0	
N5025 RN	●	●	●	○	●	●	○	●	—	5,0	±0,03	2,5	28,3	4,1	
N6030 RN	●	●	●	○	●	●	○	●	—	6,0	±0,03	3,0	28,3	4,5	

### Non-Ferrous Metals

Dimensions (mm)

Cat. No.	H1	CW		RE	L	S	Fig.
		Cutting Width	Tolerance				
GCG N2002 GA	○	2,0	±0,025	0,2	21,1	3,6	3
N3002 GA	○	3,0	±0,025	0,2	21,1	3,8	
N4004 GA	○	4,0	±0,025	0,4	26,4	4,0	
N5004 GA	○	5,0	±0,025	0,4	26,4	4,1	
N6004 GA	○	6,0	±0,025	0,4	26,4	4,5	

# Grooving Tool Holders

## GNDN Type

### Necking

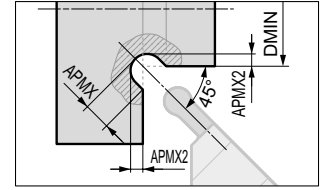
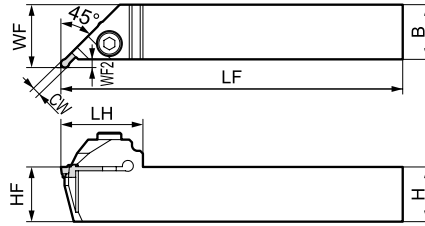
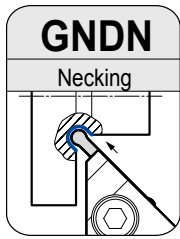

Above figures show right hand tools.

### Spare Parts



### Holders

Cat. No.	Stock		Dimensions (mm)							Min. Bore (mm)	Groov. Width (mm)	APMX	APMX2	Applicable Insert	Cap Screw	Spanner	
	R	L	H	B	LF	WF	HF	LH	WF2								DMIN
GNDN R/L2020 K 215-020	○	○	20	20	125	23	20	30	3,0	20	2,0	1,5	0,64	GCM N2010 RN	BX0520	5,0	LH040
GNDN R/L2020 K 320-020	○	○	20	20	125	23	20	30	3,0	20	3,0	2,0	0,79	GCM N3015 RN			
GNDN R/L2020 K 430-030	○	○	20	20	125	24	20	32	4,0	30	4,0	3,0	1,29	GCM N4020 RN			
GNDN R/L2020 K 535-030	○	○	20	20	125	25	20	35	5,0	30	5,0	3,5	1,44	GCM N5025 RN			
GNDN R/L2020 K 640-030	○	○	20	20	125	25	20	35	5,0	30	6,0	4,0	1,59	GCM N6030 RN			
GNDN R/L2525 M 215-020	○	○	25	25	150	28	25	30	3,0	20	2,0	1,5	0,64	GCM N2010 RN	BX0520	5,0	LH040
GNDN R/L2525 M 320-020	○	○	25	25	150	28	25	30	3,0	20	3,0	2,0	0,79	GCM N3015 RN			
GNDN R/L2525 M 430-030	○	○	25	25	150	29	25	32	4,0	30	4,0	3,0	1,29	GCM N4020 RN			
GNDN R/L2525 M 535-030	○	○	25	25	150	30	25	35	5,0	30	5,0	3,5	1,44	GCM N5025 RN			
GNDN R/L2525 M 640-030	○	○	25	25	150	30	25	35	5,0	30	6,0	4,0	1,59	GCM N6030 RN			

Select holders and inserts with the same grooving width (CW).

### Inserts for GNDN

Coated Carbide

Cermet

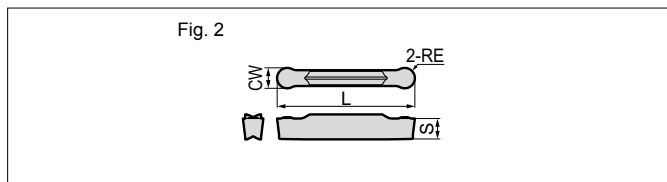

### Profiling / Radius Grooving / Necking

Cat. No.	Dimensions (mm)							CW		RE	L	S	Fig.		
	AC8025P	AC8035P	AC830P	AC425K	AC5015S	AC5025S	AC520U	AC530U	T2500A					Cutting Width	Tolerance
GCM N2010 RN	-	-	-	-	●	●	○	○	-	2,0	±0,03	1,0	21,7	3,6	2
N3015 RN	●	●	●	○	●	●	○	○	-	3,0	±0,03	1,5	22,6	3,8	
N4020 RN	●	●	○	○	●	●	○	○	-	4,0	±0,03	2,0	28,2	4,0	
N5025 RN	●	●	○	○	●	●	○	○	-	5,0	±0,03	2,5	28,3	4,1	
N6030 RN	●	●	○	○	●	●	○	○	-	6,0	±0,03	3,0	28,3	4,5	

Select holders and inserts with the same grooving width (CW).

# Grooving Tool Holders GNDXL Type



External Deep Grooving and Cut-off  
Clamp-on

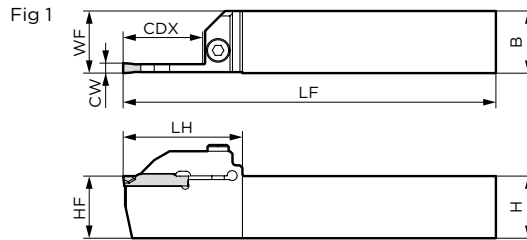
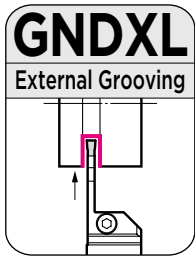

Figure shows right-handed (R) tool.

## ■ Holders

## ■ Spare Parts Dimensions (mm)

Cat. No.	Stock		Dimensions (mm)					Head	Width of Cut	Maximum Groove Depth	Max. Cut-off Dia.	Applicable Insert	Fig	Cap Screw		Wrench
	R	L	H	B	LF	WF	HF							LH	CW	
GNDXL R/L2020K-226	●	●	20	20	125	20	20	42.0	2.0	26	52	GCM N2002-GF1	1	BX0520	5.0	LH040
R/L2020K-332	●	●	20	20	125	20	20	48.0	3.0	32	64	GCM N30□□-□□1	1			
R/L2020K-432	●	●	20	20	125	20	20	48.0	4.0	32	64	GCM N40□□-□□1	1			
R/L2020K-532	●	●	20	20	125	20	20	48.0	5.0	32	64	GCM N50□□-□□1	1			
R/L2020K-632	●	●	20	20	125	20	20	48.0	6.0	32	64	GCM N60□□-□□1	1			
GNDXL R/L2525M-226	●	●	25	25	150	25	25	42.0	2.0	26	52	GCM N2002-GF1	1	BX0520	5.0	LH040
R/L2525M-332	●	●	25	25	150	25	25	48.0	3.0	32	64	GCM N30□□-□□1	1			
R/L2525M-432	●	●	25	25	150	25	25	48.0	4.0	32	64	GCM N40□□-□□1	1			
R/L2525M-532	●	●	25	25	150	25	25	48.0	5.0	32	64	GCM N50□□-□□1	1			
R/L2525M-632	●	●	25	25	150	25	25	48.0	6.0	32	64	GCM N60□□-□□1	1			

Select holders and inserts with matching width of cut (CW). Only 1-cornered inserts can be used. Refer to P33 for applicable inserts. The maximum groove depth CDX is the figure during grooving. For maximum depth of cut during traverse cutting and profiling, refer to P11.

## ■ Inserts for GNDXL type (1-cornered)

(■) Coated Carbide

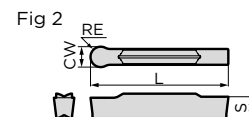
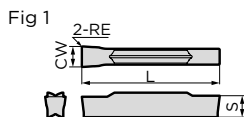

Select holders and inserts with matching width of cut (CW). Use in combination with GNDXL type holders. Not usable with GNDIS type holders.

### ● Grooving / Traverse Cutting (1-cornered)

Dimensions (mm)

Cat. No.	AC5015S	AC5025S	AC530U	Width of Cut CW		Corner Radius RE	Overall Length L	Thickness S	Pcs/Pack	Fig
				Width of Cut	Tolerance					
				GCM N3002-ML1	●	●	●	3.0		
N4004-ML1	●	●	●	4.0	±0.03	0.4	26.4	4.0	1	
N5004-ML1	●	●	●	5.0	±0.03	0.4	26.4	4.1	1	
N6004-ML1	●	●	●	6.0	±0.03	0.4	26.4	4.5	1	

### ● Profiling / Radius Grooving (1-cornered)

Dimensions (mm)

Cat. No.	AC5015S	AC5025S	AC530U	Width of Cut CW		Corner Radius RE	Overall Length L	Thickness S	Pcs/Pack	Fig
				Width of Cut	Tolerance					
				GCM N3015-RN1	●	●	●	3.0		
N6030-RN1	●	●	●	6.0	±0.03	3.0	28.3	4.5	2	

### ● Grooving / Cut-off (1-cornered)

Dimensions (mm)

Cat. No.	AC5015S	AC5025S	AC530U	Width of Cut CW		Corner Radius RE	Overall Length L	Thickness S	Pcs/Pack	Fig
				Width of Cut	Tolerance					
				GCM N2002-GF1	●	●	●	2.0		
N3002-GF1	●	●	●	3.0	±0.03	0.2	21.1	3.8	1	
N4002-GF1	●	●	●	4.0	±0.03	0.2	26.4	4.0	1	
N5002-GF1	●	●	●	5.0	±0.03	0.2	26.4	4.1	1	
N6002-GF1	●	●	●	6.0	±0.03	0.2	26.4	4.5	1	

## Part Number Suffix Code (Chipbreakers)

Type	Symbol	Applications	Type	Symbol	Applications
Grooving / Traverse Cutting	ML1	Multi-functional / Low-feed	Profiling / Radius Grooving	RN1	General-purpose
Grooving / Cut-off	GF1	Grooving / Low cutting force			

Chipbreaker Selection

Recommended Cutting Conditions

Precautions for Use

○ Japan stock

● Euro stock



# Grooving Tool Holders

## GNDF Type

### Face Grooving

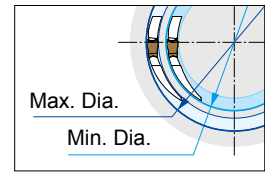
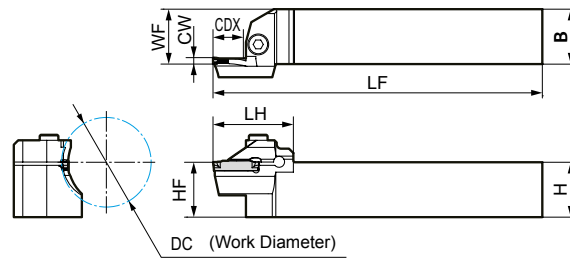
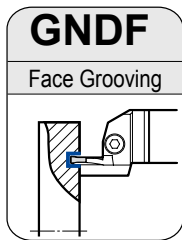

Work diameters in the stock indicate external diameters of face grooving.

Use for multi-purpose or profiling insert for turning (wide grooves).

Above figures show right hand tools.

### ■ Holders

### ■ Spare Parts

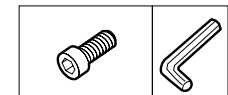

Cat. No.	Stock		Dimensions (mm)						Work Dia. (mm)	Groov. Width (mm)	Max. Cut-off Dia. (mm)	Applicable Insert	Cap Screw	N·m	Spanner				
	R	L	H	B	LF	WF	HF	LH								DC	CW	CDX	
GNDF R/L 2020 K 312-035	●	●	20	20	125	20	20	35,6	35-45	3,0	12	GCM N300O-□□	BX0520	5,0	LH040				
GNDF R/L 2020 K 312-040	●	●	20	20	125	20	20	35,6	40-55	3,0	12								
GNDF R/L 2020 K 318-050	●	●	20	20	125	20	20	41,6	50-70	3,0	18								
GNDF R/L 2020 K 318-065	●	●	20	20	125	20	20	41,6	65-100	3,0	18								
GNDF R/L 2020 K 318-090	●	●	20	20	125	20	20	41,6	90-150	3,0	18								
GNDF R/L 2020 K 318-140	●	●	20	20	125	20	20	41,6	140-200	3,0	18								
GNDF R/L 2020 K 318-180	●	●	20	20	125	20	20	41,6	180-300	3,0	18								
GNDF R/L 2020 K 418-040	●	●	20	20	125	20	20	41,6	40-55	4,0	18	GCM N400O-□□	BX0520	5,0	LH040				
GNDF R/L 2020 K 423-050	●	●	20	20	125	20	20	46,6	50-70	4,0	23								
GNDF R/L 2020 K 423-065	●	●	20	20	125	20	20	46,6	65-90	4,0	23								
GNDF R/L 2020 K 423-085	●	○	20	20	125	20	20	46,6	85-130	4,0	23								
GNDF R/L 2020 K 423-125	○	●	20	20	125	20	20	46,6	125-200	4,0	23								
GNDF R/L 2020 K 423-180	○	○	20	20	125	20	20	46,6	180-300	4,0	23								
GNDF R/L 2020 K 423-280	○	○	20	20	125	20	20	46,6	280-1000	4,0	23								
GNDF R/L 2020 K 523-050	○	○	20	20	125	20	20	46,6	50-70	5,0	23	GCM N500O-□□	BX0520	5,0	LH040				
GNDF R/L 2020 K 523-065	○	●	20	20	125	20	20	46,6	65-90	5,0	23								
GNDF R/L 2020 K 523-085	●	○	20	20	125	20	20	46,6	85-130	5,0	23								
GNDF R/L 2020 K 523-125	●	●	20	20	125	20	20	46,6	125-200	5,0	23								
GNDF R/L 2020 K 523-180	○	○	20	20	125	20	20	46,6	180-300	5,0	23								
GNDF R/L 2020 K 523-280	○	○	20	20	125	20	20	46,6	280-1000	5,0	23								
GNDF R/L 2020 K 623-050	○	○	20	20	125	20	20	46,6	50-75	6,0	23					GCM N600O-□□	BX0520	5,0	LH040
GNDF R/L 2020 K 623-070	○	○	20	20	125	20	20	46,6	70-110	6,0	23								
GNDF R/L 2020 K 623-100	○	●	20	20	125	20	20	46,6	100-200	6,0	23								
GNDF R/L 2020 K 623-180	○	○	20	20	125	20	20	46,6	180-300	6,0	23								
GNDF R/L 2020 K 623-280	○	○	20	20	125	20	20	46,6	280-1000	6,0	23								
GNDF R/L 2525 M 312-035	●	●	25	25	150	25	25	35,6	35-45	3,0	12	GCM N300O-□□	BX0520	5,0	LH040				
GNDF R/L 2525 M 312-040	●	●	25	25	150	25	25	35,6	40-55	3,0	12								
GNDF R/L 2525 M 318-050	●	●	25	25	150	25	25	41,6	50-70	3,0	18								
GNDF R/L 2525 M 318-065	●	●	25	25	150	25	25	41,6	65-100	3,0	18								
GNDF R/L 2525 M 318-090	●	●	25	25	150	25	25	41,6	90-150	3,0	18								
GNDF R/L 2525 M 318-140	●	●	25	25	150	25	25	41,6	140-200	3,0	18								
GNDF R/L 2525 M 318-180	●	●	25	25	150	25	25	41,6	180-300	3,0	18								
GNDF R/L 2525 M 418-040	●	●	25	25	150	25	25	41,6	40-55	4,0	18	GCM N400O-□□	BX0520	5,0	LH040				
GNDF R/L 2525 M 423-050	●	●	25	25	150	25	25	46,6	50-70	4,0	23								
GNDF R/L 2525 M 423-065	●	●	25	25	150	25	25	46,6	65-90	4,0	23								
GNDF R/L 2525 M 423-085	●	●	25	25	150	25	25	46,6	85-130	4,0	23								
GNDF R/L 2525 M 423-125	●	●	25	25	150	25	25	46,6	125-200	4,0	23								
GNDF R/L 2525 M 423-180	●	●	25	25	150	25	25	46,6	180-300	4,0	23								
GNDF R/L 2525 M 423-280	●	●	25	25	150	25	25	46,6	280-1000	4,0	23								
GNDF R/L 2525 M 523-050	●	●	25	25	150	25	25	46,6	50-70	5,0	23	GCM N500O-□□	BX0520	5,0	LH040				
GNDF R/L 2525 M 523-065	●	●	25	25	150	25	25	46,6	65-90	5,0	23								
GNDF R/L 2525 M 523-085	●	●	25	25	150	25	25	46,6	85-130	5,0	23								
GNDF R/L 2525 M 523-125	●	●	25	25	150	25	25	46,6	125-200	5,0	23								
GNDF R/L 2525 M 523-180	●	●	25	25	150	25	25	46,6	180-300	5,0	23								
GNDF R/L 2525 M 523-280	●	●	25	25	150	25	25	46,6	280-1000	5,0	23								
GNDF R/L 2525 M 623-050	●	○	25	25	150	25	25	46,6	50-75	6,0	23					GCM N600O-□□	BX0520	5,0	LH040
GNDF R/L 2525 M 623-070	●	●	25	25	150	25	25	46,6	70-110	6,0	23								
GNDF R/L 2525 M 623-100	●	●	25	25	150	25	25	46,6	100-200	6,0	23								
GNDF R/L 2525 M 623-180	○	●	25	25	150	25	25	46,6	180-300	6,0	23								
GNDF R/L 2525 M 623-280	●	●	25	25	150	25	25	46,6	280-1000	6,0	23								

Select holders and inserts with the same grooving width (CW).

● Euro stock

○ Japan stock

# Grooving Tool Holders GNDF Type

## Inserts for GNDF

Coated Carbide    Cermet    Carbide

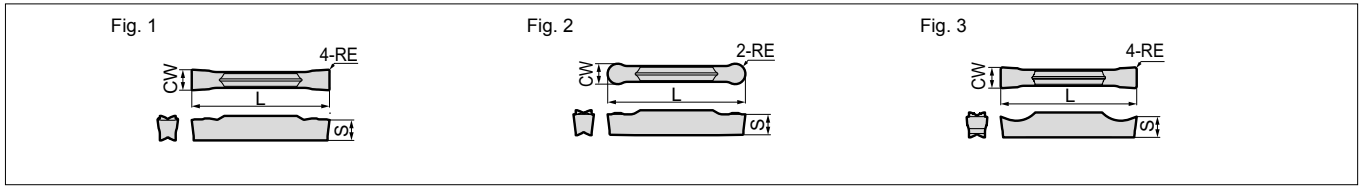

### Grooving / Traversing

Dimensions (mm)

Cat. No.	AC8025P	AC8035P	AC830P	AC425K	AC5015S	AC5025S	AC520U	AC530U	T2500A	CW		RE	L	S	Fig.
										Cutting Width	Tolerance				
GCM N3002 MG	●	●	●	○	●	●	●	●	—	3,0	±0,03	0,2	21,1	3,8	1
N3004 MG	●	●	●	○	●	●	●	●	—	±0,03	0,4	21,1	3,8		
N4002 MG	●	●	●	○	●	●	●	●	—	±0,03	0,2	26,4	4,0		
N4004 MG	●	●	●	○	●	●	●	●	—	±0,03	0,4	26,4	4,0		
N4008 MG	●	●	●	○	●	●	●	●	—	±0,03	0,8	26,4	4,0		
N5004 MG	●	●	●	○	●	●	●	●	—	±0,03	0,4	26,4	4,1		
N5008 MG	●	●	●	○	●	●	●	●	—	±0,03	0,8	26,4	4,1		
N6004 MG	●	●	●	○	●	●	●	●	—	±0,03	0,4	26,4	4,5		
N6008 MG	●	●	●	○	●	●	●	●	—	±0,03	0,8	26,4	4,5		
GCM N2002 ML	—	—	—	—	●	●	●	●	—	2,0	±0,03	0,2	21,1	3,6	1
N3002 ML	●	●	●	○	●	●	●	●	—	±0,03	0,2	21,1	3,8		
N3004 ML	●	●	●	○	●	●	●	●	—	±0,03	0,4	21,1	3,8		
N4002 ML	●	●	●	○	●	●	●	●	—	±0,03	0,2	26,4	4,0		
N4004 ML	●	●	●	○	●	●	●	●	—	±0,03	0,4	26,4	4,0		
N4008 ML	●	●	●	○	●	●	●	●	—	±0,03	0,8	26,4	4,0		
N5004 ML	●	●	●	○	●	●	●	●	—	±0,03	0,4	26,4	4,1		
N5008 ML	●	●	●	○	●	●	●	●	—	±0,03	0,8	26,4	4,1		
N6004 ML	●	●	●	○	●	●	●	●	—	±0,03	0,4	26,4	4,5		
N6008 ML	●	●	●	○	●	●	●	●	—	±0,03	0,8	26,4	4,5		

### Grooving / Cut-Off Machining

Dimensions (mm)

Cat. No.	AC8035P	AC830P	AC5015S	AC5025S	AC520U	AC530U	T2500A	CW		RE	L	S	Fig.
								Cutting Width	Tolerance				
GCM N3002 GG	●	●	●	●	○	●	—	3,0	±0,03	0,2	21,1	3,8	1
N3004 GG	●	●	●	●	○	●	—	±0,03	0,4	21,1	3,8		
N4002 GG	●	●	●	●	○	●	—	±0,03	0,2	26,4	4,0		
N4004 GG	●	●	●	●	○	●	—	±0,03	0,4	26,4	4,0		
N5002 GG	●	●	●	●	○	●	—	±0,03	0,2	26,4	4,1		
N5004 GG	●	●	●	●	○	●	—	±0,03	0,4	26,4	4,1		
N6002 GG	●	●	●	●	○	●	—	±0,03	0,2	26,4	4,5		
N6004 GG	●	●	●	●	○	●	—	±0,03	0,4	26,4	4,5		
GCM N3002 GL	●	●	●	●	○	●	—	3,0	±0,03	0,2	21,1	3,8	1
N3004 GL	●	●	●	●	○	●	—	±0,03	0,4	21,1	3,8		
N4002 GL	●	●	●	●	○	●	—	±0,03	0,2	26,4	4,0		
N4004 GL	●	●	●	●	○	●	—	±0,03	0,4	26,4	4,0		
N5002 GL	●	●	●	●	○	●	—	±0,03	0,2	26,4	4,1		
N5004 GL	●	●	●	●	○	●	—	±0,03	0,4	26,4	4,1		
N6002 GL	●	●	●	●	○	●	—	±0,03	0,2	26,4	4,5		
N6004 GL	●	●	●	●	○	●	—	±0,03	0,4	26,4	4,5		
GCM N3002 GF	●	●	●	●	○	●	—	3,0	±0,03	0,2	21,1	3,8	1
N3004 GF	●	●	●	●	○	●	—	±0,03	0,4	21,1	3,8		
N4002 GF	●	●	●	●	○	●	—	±0,03	0,2	26,4	4,0		
N4004 GF	●	●	●	●	○	●	—	±0,03	0,4	26,4	4,0		
N5002 GF	●	●	●	●	○	●	—	±0,03	0,2	26,4	4,1		
N5004 GF	●	●	●	●	○	●	—	±0,03	0,4	26,4	4,1		
N6002 GF	●	●	●	●	○	●	—	±0,03	0,2	26,4	4,5		
N6004 GF	●	●	●	●	○	●	—	±0,03	0,4	26,4	4,5		

Combine the insert with a holder such that the width of cut (CW) matches.

### Profiling / Radius Grooving / Necking

Dimensions (mm)

Cat. No.	AC8025P	AC8035P	AC830P	AC425K	AC5015S	AC5025S	AC520U	AC530U	T2500A	CW		RE	L	S	Fig.
										Cutting Width	Tolerance				
GCM N3015 RG	●	●	●	●	●	●	●	●	○	3,0	±0,03	1,5	21,1	3,8	2
N4020 RG	●	●	●	●	●	●	●	●	○	4,0	±0,03	2,0	26,4	4,0	
N5025 RG	●	●	●	●	●	●	●	●	○	5,0	±0,03	2,5	27,2	4,1	
N6030 RG	●	●	●	●	●	●	●	●	○	6,0	±0,03	3,0	27,5	4,5	

### Non-Ferrous Metals

Dimensions (mm)

Cat. No.	H1	CW		RE	L	S	Fig.
		Cutting Width	Tolerance				
GCG N3002 GA	○	3,0	±0,025	0,2	21,1	3,8	3
N4004 GA	○	4,0	±0,025	0,4	26,4	4,0	
N5004 GA	○	5,0	±0,025	0,4	26,4	4,1	
N6004 GA	○	6,0	±0,025	0,4	26,4	4,5	

# Grooving Tool Holders

## GNDFS Type

### Face Grooving L-Styled (Non-Adjustable Type)

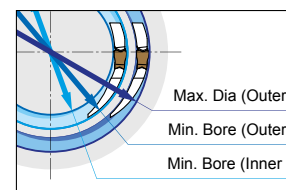
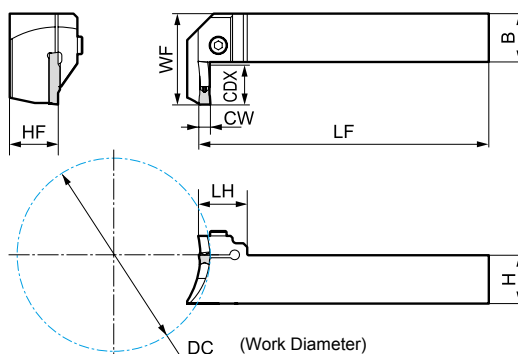
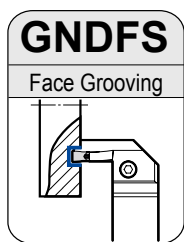

Use the multi-purpose copying inserts for turning (wide grooves).

Above figures show right hand tools.

### ■ Holders

Cat. No.	Stock		Dimensions (mm)						Work Dia. (mm)	Min. Bore Ø Inner (mm)	Groov. Width (mm)	Max. Groov. Depth (mm)	Applicable Insert	Cap Screw	N·m	Spanner
	R	L	H	B	LF	WF	HF	LH								
GNDFS R/L2525M 620 070			25	25	150	47	25	25	70-100	58	6,0	20	GC□ N60○○-□□	BX0520	5,0	LH040
GNDFS R/L2525M 620 100			25	25	150	47	25	25	100-200	88	6,0	20				
GNDFS R/L2525M 620 180			25	25	150	47	25	25	180-300	168	6,0	20				
GNDFS R/L2525M 620 280			25	25	150	47	25	25	280-1000	268	6,0	20				
GNDFS R/L2525M 620 450			25	25	150	47	25	25	>450	438	6,0	20				
GNDFS R/L3232P 620 070			32	32	170	54	32	25	70-100	58	6,0	20	GC□ N60○○-□□	BX0620	6,0	LH050
GNDFS R/L3232P 620 100			32	32	170	54	32	25	100-200	88	6,0	20				
GNDFS R/L3232P 620 180			32	32	170	54	32	25	180-300	168	6,0	20				
GNDFS R/L3232P 620 280			32	32	170	54	32	25	280-1000	268	6,0	20				
GNDFS R/L3232P 620 450			32	32	170	54	32	25	>450	438	6,0	20				
GNDFS R/L2525M 820 070			25	25	150	47	25	30	70-100	54	8,0	20	GCM N80○○-□□	BX0620	6,0	LH050
GNDFS R/L2525M 820 100			25	25	150	47	25	30	100-200	84	8,0	20				
GNDFS R/L2525M 820 180			25	25	150	47	25	30	180-300	164	8,0	20				
GNDFS R/L2525M 820 280			25	25	150	47	25	30	280-1000	264	8,0	20				
GNDFS R/L2525M 820 450			25	25	150	47	25	30	>450	434	8,0	20				
GNDFS R/L3232P 820 070			32	32	170	54	32	30	70-100	54	8,0	20	GCM N80○○-□□	BX0620	6,0	LH050
GNDFS R/L3232P 820 100			32	32	170	54	32	30	100-200	84	8,0	20				
GNDFS R/L3232P 820 180			32	32	170	54	32	30	180-300	164	8,0	20				
GNDFS R/L3232P 820 280			32	32	170	54	32	30	280-1000	264	8,0	20				
GNDFS R/L3232P 820 450			32	32	170	54	32	30	>450	434	8,0	20				

Select holders and inserts with the same grooving width (CW).

### ■ Spare Parts



# Grooving Tool Holders GNDFS Type

## Inserts for GNDFS

Coated Carbide    Cermet    Carbide

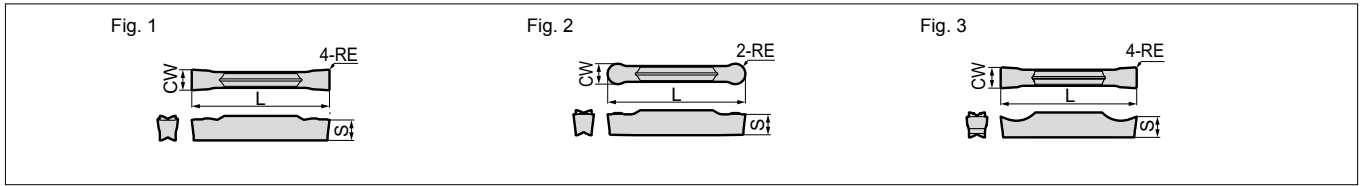

### Grooving / Traversing

Dimensions (mm)



Cat. No.	AC8025P	AC8035P	AC830P	AC425K	AC5015S	AC5025S	AC520U	AC530U	T2500A	CW		RE	L	S	Fig.
										Cutting Width	Tolerance				
GCM N6004 MG	●	●	●	○	●	●	○	○	—	6,0	±0,03	0,4	26,4	4,5	1
N6008 MG	●	●	●	○	●	●	○	○	—	8,0	±0,03	0,8	26,4	4,5	
N8004 MG	●	●	●	○	●	●	○	○	—	8,0	±0,04	0,4	28,8	6,0	
N8008 MG	●	●	●	○	●	●	○	○	—	8,0	±0,04	0,8	28,8	6,0	
GCM N6004 ML	●	●	●	○	●	●	○	○	—	6,0	±0,03	0,4	26,4	4,5	1
N6008 ML	●	●	●	○	●	●	○	○	—	8,0	±0,03	0,8	26,4	4,5	
N8004 ML	●	●	●	○	●	●	○	○	—	8,0	±0,04	0,4	28,8	6,0	
N8008 ML	●	●	●	○	●	●	○	○	—	8,0	±0,04	0,8	28,8	6,0	

### Grooving / Cut-Off Machining

Dimensions (mm)



Cat. No.	AC8035P	AC830P	AC5015S	AC5025S	AC520U	AC530U	T2500A	CW		RE	L	S	Fig.
								Cutting Width	Tolerance				
GCM N6002 GG	●	●	●	●	○	○	—	6,0	±0,03	0,2	26,4	4,5	1
N6004 GG	●	●	●	●	○	○	—	8,0	±0,03	0,4	26,4	4,5	
N8004 GG	●	●	●	●	○	○	—	8,0	±0,04	0,4	28,8	6,0	
GCM N6002 GL	●	●	●	●	○	○	—	6,0	±0,03	0,2	26,4	4,5	1
N6004 GL	●	●	●	●	○	○	—	8,0	±0,03	0,4	26,4	4,5	
N8004 GL	●	○	●	●	○	○	—	8,0	±0,04	0,4	28,8	6,0	
GCM N6002 GF	●	●	●	●	○	○	—	6,0	±0,03	0,2	26,4	4,5	1
N6004 GF	●	●	●	●	○	○	—	8,0	±0,03	0,4	26,4	4,5	
N8002 GF	●	●	●	●	○	○	—	8,0	±0,04	0,2	28,8	6,0	
N8004 GF	●	●	●	●	○	○	—	8,0	±0,04	0,4	28,8	6,0	

### Profiling / Radius Grooving / Necking

Dimensions (mm)



Cat. No.	AC8025P	AC8035P	AC830P	AC425K	AC5015S	AC5025S	AC520U	AC530U	T2500A	CW		RE	L	S	Fig.
										Cutting Width	Tolerance				
GCM N6030 RN	●	●	●	●	●	●	○	○	—	6,0	±0,03	3,0	28,3	4,5	2

Combine the insert with a holder such that the width of cut (CW) matches.

### Non-Ferrous Metals

Dimensions (mm)



Cat. No.	H1									CW		RE	L	S	Fig.	
		Cutting Width	Tolerance													
GCG N6004 GA	○										6,0	±0,025	0,4	26,4	4,5	3

# Grooving Tool Holders

## GNDI Type

### Internal Grooving

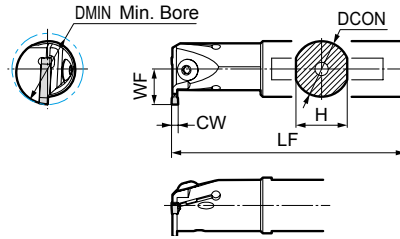
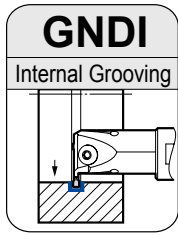

Use for multi-purpose or profiling insert for turning (wide grooves).

Above figures show right hand tools.

### Spare Parts

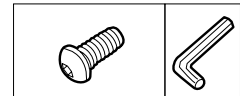

### Holders

Cat. No.	Stock		Dimensions (mm)				Min. Bore (mm)	Groov. Width (mm)	Max. Groov. Depth (mm)	Applicable Insert	Cap Screw	N·m	Spanner
	R	L	DCON	H	LF	WF							
GNDI R/L 2532 T 206	●	●	25	23	200	16	32	2,0	6	GCM N2000-□□	BH0516	5,0	LH030
GNDI R/L 3240 T 210	●	●	32	30	250	26	40	2,0	10	GCM N2000-□□	BH0616	6,0	LH040
GNDI R/L 2532 T 306	●	●	25	23	200	16	32	3,0	6	GCM N3000-□□	BH0516	5,0	LH030
GNDI R/L 3240 T 310	●	●	32	30	250	26	40	3,0	10	GCM N3000-□□	BH0616	6,0	LH040
GNDI R/L 4050 T 311	●	●	40	38	300	31	50	3,0	11	GCM N3000-□□	BH0616	6,0	LH040
GNDI R/L 2532 T 406	●	●	25	23	200	19	32	4,0	6	GCM N4000-□□	BH0516	5,0	LH030
GNDI R/L 3240 T 410	●	●	32	30	250	26	40	4,0	10	GCM N4000-□□	BH0616	6,0	LH040
GNDI R/L 4050 T 411	●	●	40	38	300	31	50	4,0	11	GCM N4000-□□	BH0616	6,0	LH040
GNDI R/L 2532 T 506	●	○	25	23	200	19	32	5,0	6	GCM N5000-□□	BH0516	5,0	LH030
GNDI R/L 3240 T 510	●	●	32	30	250	26	40	5,0	10	GCM N5000-□□	BH0616	6,0	LH040
GNDI R/L 4050 T 511	●	●	40	38	300	31	50	5,0	11	GCM N5000-□□	BH0616	6,0	LH040
GNDI R/L 4050 T 611	●	●	40	38	300	31	50	6,0	11	GCM N6000-□□	BH0616	6,0	LH040

Select holders and inserts with the same grooving width (CW).

## Inserts for GNDI

Coated Carbide    
  Cermet    
  Carbide

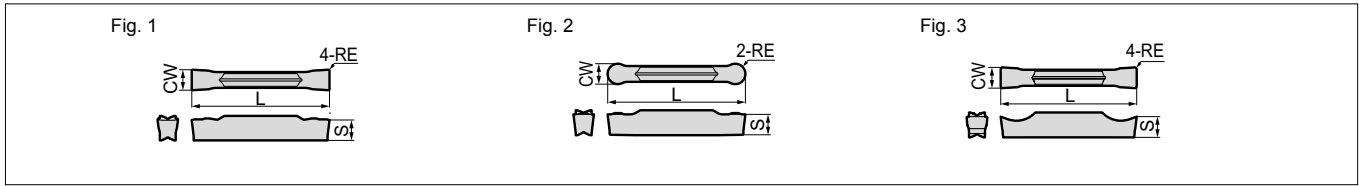

### Grooving / Traversing

Dimensions (mm)

Cat. No.	AC8025P	AC8035P	AC830P	AC425K	AC5015S	AC5025S	AC520U	AC530U	T2500A	CW		RE	L	S	Fig.
										Cutting Width	Tolerance				
GCM N3002 MG	●	●	●	○	●	●	●	●	—	3,0	±0,03	0,2	21,1	3,8	1
N3004 MG	●	●	●	○	●	●	●	●	—	±0,03	0,4	21,1	3,8		
N4002 MG	●	●	●	○	●	●	●	●	—	±0,03	0,2	26,4	4,0		
N4004 MG	●	●	●	○	●	●	●	●	—	±0,03	0,4	26,4	4,0		
N4008 MG	●	●	●	○	●	●	○	●	—	±0,03	0,8	26,4	4,0		
N5004 MG	●	●	●	○	●	●	○	●	—	±0,03	0,4	26,4	4,1		
N5008 MG	●	●	●	○	●	●	○	●	—	±0,03	0,8	26,4	4,1		
N6004 MG	●	●	●	○	●	●	○	●	—	±0,03	0,4	26,4	4,5		
N6008 MG	●	●	●	○	●	●	○	●	—	±0,03	0,8	26,4	4,5		
GCM N2002 ML	—	—	—	—	○	○	○	○	—	2,0	±0,03	0,2	21,1	3,6	1
N3002 ML	●	●	●	○	●	●	○	○	—	±0,03	0,2	21,1	3,8		
N3004 ML	●	●	●	○	●	●	○	○	—	±0,03	0,4	21,1	3,8		
N4002 ML	●	●	●	○	●	●	○	○	—	±0,03	0,2	26,4	4,0		
N4004 ML	●	●	●	○	●	●	○	○	—	±0,03	0,4	26,4	4,0		
N4008 ML	●	●	●	○	●	●	○	○	—	±0,03	0,8	26,4	4,0		
N5004 ML	●	●	●	○	●	●	○	○	—	±0,03	0,4	26,4	4,1		
N5008 ML	●	●	●	○	●	●	○	○	—	±0,03	0,8	26,4	4,1		
N6004 ML	●	●	●	○	●	●	○	○	—	±0,03	0,4	26,4	4,5		
N6008 ML	●	●	●	○	●	●	○	○	—	±0,03	0,8	26,4	4,5		

### Grooving / Cut-Off Machining

Dimensions (mm)

Cat. No.	AC8035P	AC830P	AC5015S	AC5025S	AC520U	AC530U	T2500A	CW		RE	L	S	Fig.
								Cutting Width	Tolerance				
GCM N2002 GG	●	●	●	●	○	○	—	2,0	±0,03	0,2	21,1	3,6	1
N3002 GG	●	●	●	●	○	○	—	±0,03	0,2	21,1	3,8		
N3004 GG	●	●	●	●	○	○	—	3,0	±0,03	0,4	21,1	3,8	
N4002 GG	●	●	●	●	○	○	—	±0,03	0,2	26,4	4,0		
N4004 GG	●	●	●	●	○	○	—	±0,03	0,4	26,4	4,0		
N5002 GG	●	●	●	●	○	○	—	5,0	±0,03	0,2	26,4	4,1	
N5004 GG	●	●	●	●	○	○	—	±0,03	0,4	26,4	4,1		
N6002 GG	●	●	●	●	○	○	—	±0,03	0,2	26,4	4,5		
N6004 GG	●	●	●	●	○	○	—	±0,03	0,4	26,4	4,5		
GCM N2002 GL	●	●	●	●	○	○	—	2,0	±0,03	0,2	21,1	3,6	1
N2004 GL	●	●	●	●	○	○	—	±0,03	0,4	21,1	3,6		
N3002 GL	●	●	●	●	○	○	—	3,0	±0,03	0,2	21,1	3,8	
N3004 GL	●	●	●	●	○	○	—	±0,03	0,4	21,1	3,8		
N4002 GL	●	●	●	●	○	○	—	±0,03	0,2	26,4	4,0		
N4004 GL	●	●	●	●	○	○	—	±0,03	0,4	26,4	4,0		
N5002 GL	●	●	●	●	○	○	—	5,0	±0,03	0,2	26,4	4,1	
N5004 GL	●	●	●	●	○	○	—	±0,03	0,4	26,4	4,1		
N6002 GL	●	●	●	●	○	○	—	±0,03	0,2	26,4	4,5		
N6004 GL	●	●	●	●	○	○	—	±0,03	0,4	26,4	4,5		
GCM N2002 GF	—	—	●	●	○	○	—	2,0	±0,03	0,2	21,1	3,6	1
N2004 GF	—	—	●	●	○	○	—	±0,03	0,4	21,1	3,6		
N3002 GF	●	●	●	●	○	○	—	3,0	±0,03	0,2	21,1	3,8	
N3004 GF	●	●	●	●	○	○	—	±0,03	0,4	21,1	3,8		
N4002 GF	●	●	●	●	○	○	—	±0,03	0,2	26,4	4,0		
N4004 GF	●	●	●	●	○	○	—	±0,03	0,4	26,4	4,0		
N5002 GF	●	●	●	●	○	○	—	5,0	±0,03	0,2	26,4	4,1	
N5004 GF	●	●	●	●	○	○	—	±0,03	0,4	26,4	4,1		
N6002 GF	●	●	●	●	○	○	—	±0,03	0,2	26,4	4,5		
N6004 GF	●	●	●	●	○	○	—	±0,03	0,4	26,4	4,5		

Combine the insert with a holder such that the width of cut (CW) matches.

### External Profiling / External Radius Grooving

Dimensions (mm)

Cat. No.	AC8025P	AC8035P	AC830P	AC425K	AC5015S	AC5025S	AC520U	AC530U	T2500A	CW		RE	L	S	Fig.
										Cutting Width	Tolerance				
GCM N3015 RG	●	●	●	●	●	●	○	○	—	3,0	±0,03	1,5	21,1	3,8	2
N4020 RG	●	●	●	●	●	●	○	○	—	4,0	±0,03	2,0	26,4	4,0	
N5025 RG	●	●	●	●	●	●	○	○	—	5,0	±0,03	2,5	27,2	4,1	
N6030 RG	●	●	●	●	●	●	○	○	—	6,0	±0,03	3,0	27,5	4,5	

### Profiling / Radius Grooving / Necking

Dimensions (mm)

Cat. No.	AC8025P	AC8035P	AC830P	AC425K	AC5015S	AC5025S	AC520U	AC530U	T2500A	CW		RE	L	S	Fig.
										Cutting Width	Tolerance				
GCM N2010 RN	—	—	—	—	○	○	○	○	—	2,0	±0,03	1,0	21,7	3,6	2
N3015 RN	●	●	●	○	●	●	○	○	—	3,0	±0,03	1,5	22,6	3,8	
N4020 RN	●	●	●	○	●	●	○	○	—	4,0	±0,03	2,0	28,2	4,0	
N5025 RN	●	●	●	○	●	●	○	○	—	5,0	±0,03	2,5	28,3	4,1	
N6030 RN	●	●	●	○	●	●	○	○	—	6,0	±0,03	3,0	28,3	4,5	

### Non-Ferrous Metals

Dimensions (mm)

Cat. No.	H1	CW		RE	L	S	Fig.
		Cutting Width	Tolerance				
GCG N2002 GA	○	2,0	±0,025	0,2	21,1	3,6	3
N3002 GA	○	3,0	±0,025	0,2	21,1	3,8	
N4004 GA	○	4,0	±0,025	0,4	26,4	4,0	
N5004 GA	○	5,0	±0,025	0,4	26,4	4,1	
N6004 GA	○	6,0	±0,025	0,4	26,4	4,5	



# Grooving Tool Holders

## GNDIS Type

### Internal Grooving

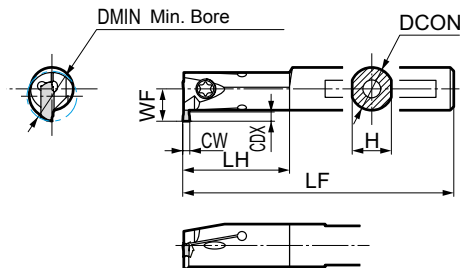
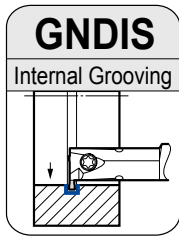

Above figures show right hand tools.

### ■ Spare Parts

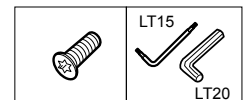

### ■ Holders

Cat. No.	Stock		Dimensions (mm)					Min. Bore (mm)	Groov. Width (mm)	Max. Groov. Depth (mm)	Applicable Insert	Cap Screw	Spanner
	R	L	DCON	H	LF	LH	WF						
GNDIS R/L 1214 T 1526	○	○	12	11	150	30	9,0	14	1,5	2,6	GXM N150005S GF		
GNDIS R/L 1214 T 1536	○	○	12	11	150	30	10,0	14	1,5	3,6	GXM N150005S GF	BFTX0409N	3,4 LT15
GNDIS R/L 1616 T 1536	○	○	16	15	160	35	11,5	16	1,5	3,6	GXM N150005S GF		
GNDIS R/L 1620 T 1546	○	○	16	15	160	40	14,5	20	1,5	4,6	GXM N150005S GF	BFTX0511N	5,0 LT20
GNDIS R/L 2025 T 1566	○	○	20	19	180	40	19,0	25	1,5	6,6	GXM N150005S GF		
GNDIS R/L 1214 T 2026	○	○	12	11	150	30	9,0	14	2,0	2,6	GXM N2002S-□□		
GNDIS R/L 1214 T 2036	○	○	12	11	150	30	10,0	14	2,0	3,6	GXM N2002S-□□	BFTX0409N	3,4 LT15
GNDIS R/L 1616 T 2036	○	○	16	15	160	35	11,5	16	2,0	3,6	GXM N2002S-□□		
GNDIS R/L 1620 T 2046	○	○	16	15	160	40	14,5	20	2,0	4,6	GXM N2002S-□□	BFTX0511N	5,0 LT20
GNDIS R/L 2025 T 2066	○	○	20	19	180	40	19,0	25	2,0	6,6	GXM N2002S-□□		
GNDIS R/L 1214 T 3026	○	○	12	11	150	30	9,0	14	3,0	2,6	GXM N3002S-□□		
GNDIS R/L 1214 T 3036	○	○	12	11	150	30	10,0	14	3,0	3,6	GXM N3002S-□□	BFTX0409N	3,4 LT15
GNDIS R/L 1616 T 3036	○	○	16	15	160	35	11,5	16	3,0	3,6	GXM N3002S-□□		
GNDIS R/L 1620 T 3046	○	○	16	15	160	40	14,5	20	3,0	4,6	GXM N3002S-□□	BFTX0511N	5,0 LT20
GNDIS R/L 2025 T 3066	○	○	20	19	180	40	19,0	25	3,0	6,6	GXM N3002S-□□		

Select holders and inserts with the same grooving width (CW).

Only GXM inserts can be used.

## Inserts for GNDIS

Coated Carbide

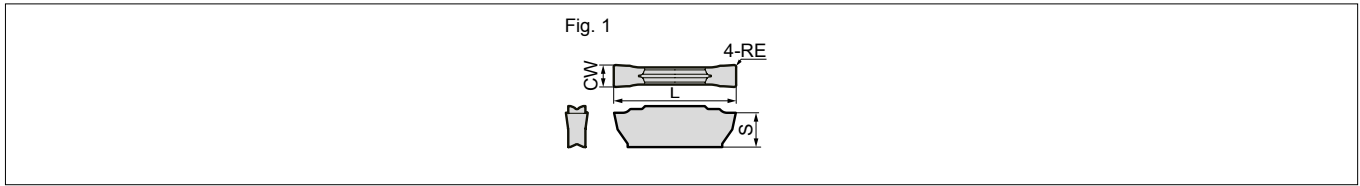

### Grooving / Traversing

Dimensions (mm)



Cat. No.	AC520U	AC1030U	CW		RE	L	S	Fig.
			Cutting Width	Tolerance				
GXM N2002S ML	○	○	2,0	±0,03	0,2	11,1	3,1	1
N3002S ML	○	○	3,0	±0,03	0,2	11,1	3,1	1

Select holders and inserts with the same grooving width (CW).

### Grooving / Cut-Off Machining

Dimensions (mm)



Cat. No.	AC520U	AC1030U	CW		RE	L	S	Fig.
			Cutting Width	Tolerance				
GXM N150005S GF	—	○	1,5	±0,03	0,2	21,1	3,6	1
N2002S GF	○	○	2,0	±0,03	0,2	21,1	3,8	1
N3002S GF	○	○	3,0	±0,03	0,4	21,1	3,8	1

GCM and GCG inserts are not compatible.

## Recommended Cutting Conditions

Work Material	P Carbon Steel / Alloy Steel		M Stainless Steel		K Cast Iron		S Exotic Alloy	
Grade	AC520U	AC1030U	AC520U	AC1030U	AC520U	AC1030U	AC520U	AC1030U
Cutting Speed (m/min)	80–200	50–200	70–150	50–150	60–200	50–200	20–80	20–60

### Grooving / Cut-Off Machining / Necking

Chipbreaker		Feed Rate (mm/rev)	
		ML	GF
Width of Cut CW (mm)	1,5	—	0,02–0,10
	2,0	0,03–0,12	0,03–0,12
	3,0	0,05–0,15	0,05–0,15

### Traversing

Chipbreaker		ML	
		Feed Rate (mm/rev)	Depth of Cut (mm)
Width of Cut CW (mm)	2,0	0,03–0,12	0,2–0,8
	3,0	0,05–0,15	0,3–1,2

# Grooving Tool Holders GND Series

## Application Examples

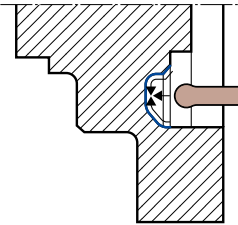
20CrMo5, Automotive Part, Face Profiling	
	<b>Target:</b> - Higher rigidity - Vibration reduction - Chip control - Wear resistance performance
	Holder: GDNF R2525M 423-125 Insert: GCM N4020 RG Grooving width: 4,0 mm Cutting conditions: $v_c = 200$ m/min $f = 0,14$ mm/rev wet
Stable machining free of vibration! Excellent chip control using the GND type.	

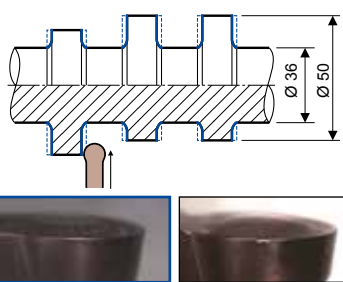
C53, Cam Shaft Grooving / Finishing (Contin. to Heavy Interrupted)	
	<b>Target:</b> - Higher rigidity - Vibration reduction - Chip control - Fracture resistance
	Holder: GNDM L2525M 618 Insert: GCM N6030 RG Grooving width: 6,0 mm Cutting conditions: $v_c = 130$ m/min $f = 0,36$ mm/rev wet
Stable machining free of vibration! Excellent fracture resistance Stable chip control	

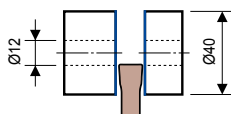
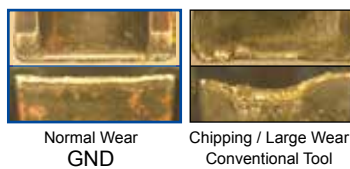
C48, Machine Part, Cut-Off	
	<b>Target:</b> - Higher rigidity - Vibration reduction - Fracture resistance
	Holder: GNDL R2525M 320 Insert: GCM N3002 GG Grooving width: 3,0 mm Cutting conditions: $n = 1600$ min <sup>-1</sup> $v_c = 200$ m/min $f = 0,05$ mm/rev wet
	
Stable machining free of vibration! Excellent fracture resistance	

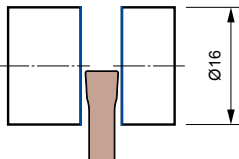
34CrMo4, Tempered Material Hydraulic Component, Cut-Off	
	<b>Target:</b> - Chip control - Wear resistance
	Holder: GNDL R2525M 320 Insert: GCM N3002 GG Grooving width: 3,0 mm Cutting conditions: $n = 4.000$ min <sup>-1</sup> $v_c = 200$ m/min $f = 0,05$ mm/rev wet
Stable chip control Excellent wear resistance	

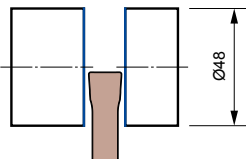
X40CrVMo5-1, (45-48HRC), Machine Part, Cut-Off	
	<b>Target:</b> - Higher rigidity - Vibration reduction - Chip control
	Holder: GNDL R2525M 425 Insert: GCM N4002 GG Grooving width: 4,0 mm Cutting conditions: $v_c = 50$ m/min $f = 0,03$ mm/rev wet
Stable machining free of vibration! Excellent chip control using the GND type. No more unexpected breakage!	

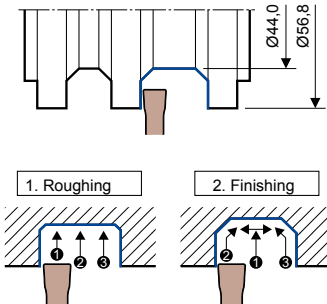
20Cr4, Gear Shaft, Grooving / Pocketing	
	<b>Target:</b> - Higher rigidity - Vibration reduction - Chip control
	Holder: GNDM R2020K 518 Insert: GCM N5008 MG Grooving width: 5,0 mm Cutting conditions: $v_c = 150$ m/min $f = 0,1$ mm/rev wet
Stable machining free of vibration! Excellent chip control using the GND type.	

## Application Examples

34CrMo4, Crank, Cut-Off	
	<p><b>Target:</b></p> <ul style="list-style-type: none"> <li>- Higher rigidity</li> <li>- Vibration reduction</li> <li>- Chip control</li> </ul>
	<p>Holder: GNDL R2525M 320</p> <p>Insert: GCM N3002 GG</p> <p>Grooving width: 3,0 mm</p> <p>Cutting conditions: <math>v_c = 115</math> m/min <math>f = 0,30</math> mm/rev wet</p>
<p>Improved efficiency</p> <p>Stable machining free of vibration</p> <p>Stable chip control</p>	

20Cr4, Gear Shaft, Grooving	
	<p><b>Target:</b></p> <ul style="list-style-type: none"> <li>- Higher rigidity</li> <li>- Chattering reduction</li> <li>- Chip control</li> </ul>
	<p>Holder: GNDM R2525M 312</p> <p>Insert: GCM N3004 GG</p> <p>Grooving width: 3,0 mm</p> <p>Cutting conditions: <math>v_c = 100</math> m/min <math>f = 0,12</math> mm/rev wet</p>
<p>Stable machining without chattering or vibration</p> <p>Excellent chip control of GND type</p>	

Sintered Clutch Hub, Face Grooving	
	<p><b>Target:</b></p> <ul style="list-style-type: none"> <li>- Machining efficiency</li> <li>- Chattering reduction</li> </ul>
	<p>Holder: GDNF R2020K 523 050</p> <p>Insert: GCM N5008 MG</p> <p>Grooving width: 5,0 mm</p> <p>Cutting conditions: <math>n = 500</math> min<sup>-1</sup> <math>v_c = 100</math> m/min <math>f = 0,05</math> mm/rev wet</p>
<p>Reduces cycle time by up to 20%</p> <p>Stable cutting without chattering or vibration</p>	

C45, Motorcycle Transmission Part (Collar), Internal Grooving	
	<p><b>Target:</b></p> <ul style="list-style-type: none"> <li>- Tool life</li> <li>- Chip control</li> </ul>
	<p>Holder: GNDIS R1620 T2046</p> <p>Insert: GXM N2002S GF</p> <p>Grooving width: 2,0 mm</p> <p>Cutting conditions: <math>v_c = 150</math> m/min <math>f = 0,03</math> mm/rev <math>a_p = 1,7</math> mm wet</p>
<p>Long tool life through stable chip control using a high-rigidity tool and 3D breaker</p>	

34CrMo4, Machine Component, Cut-Off	
	<p><b>Target:</b></p> <ul style="list-style-type: none"> <li>- Machined surface</li> <li>- Tool life</li> </ul>
	<p>Holder: GNDM R2020K 210</p> <p>Insert: GCM R20003 CF15</p> <p>Grooving width: 2,0 mm</p> <p>Cutting conditions: <math>n = 2.500</math> min<sup>-1</sup> <math>f = 0,04</math> mm/rev wet</p>
<p>Superior chip control for machined surface improvements</p> <p>Impressive sharpness with 1,8x tool life</p>	

Pure Iron Automotive Component, Cut-Off	
	<p><b>Target:</b></p> <ul style="list-style-type: none"> <li>- Machining efficiency</li> <li>- Tool life</li> </ul>
	<p>Holder: GNDM R1616JX 216J (special type)</p> <p>Insert: GCM N2002 GF</p> <p>Grooving width: 2,0 mm</p> <p>Cutting conditions: <math>v_c = 150</math> m/min max. <math>f = 0,06</math> mm/rev wet - internal coolant (normal pressure)</p>
<p>Internal coolant ensures effective cooling of the cutting edge for 4 times better tool life</p> <p>Reduced tool changes for long-term automatic operation</p> <p>Improved productivity made possible by changing to high-speed conditions</p>	

# ISO-PSC Polygon Modular GND Grooving System

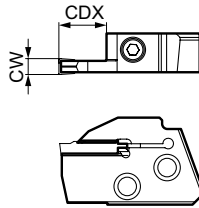
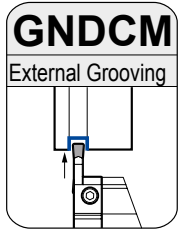

## General Features

New grades and chipbreakers have been added to the already established GND grooving system with polygon shank and a flexible and economical cassette system for inserts. An array of chipbreakers improves the efficiency in chip control in various applications such as grooving, turning, profiling and cut-off.

## Advantages

- GND inserts for soft grooving from 2,0 - 6,0 mm width
- Expanded grade selection with 9 different chipbreakers for a wide application range
- Provides excellent chip control
- Achieves stable long tool life

## Cassette

Cat. No.	R	L	CW (mm)	CDX (mm)	Inserts	Cap Screw	Tightening Torque (N·m)	Spanner
GND MCM R/L 212	●	●	2	12	GCM □2000-□□	BX0512	5,0	LH040
GND MCM R/L 312	●	●	3		GCM □3000-□□			
GND MCM R/L 418	●	●	4	GCM □4000-□□				
GND MCM R/L 518	●	●	5	GCM □5000-□□				
GND MCM R/L 618	●	●	6	GCM □6000-□□				
				GCM □6000-□□				

## Handling

### ATTENTION

To fix the cassette on the holder, please clamp the cassette at first with the inner torx screw.

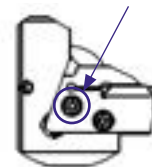

## Holder

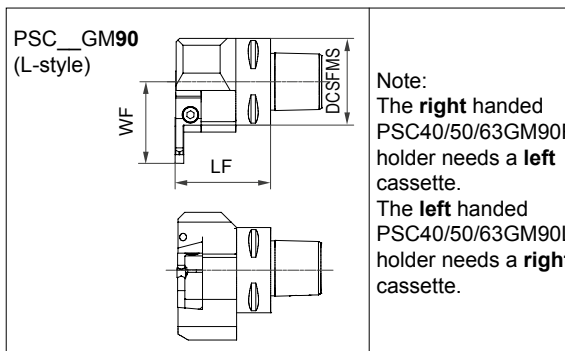
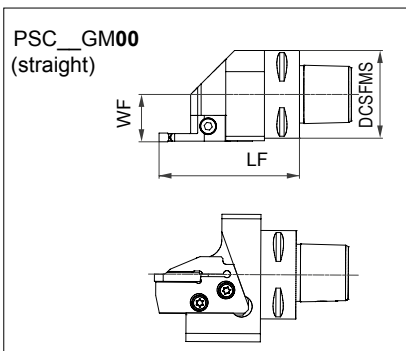

Note:  
The **right** handed PSC40/50/63GM90R holder needs a **left** cassette.  
The **left** handed PSC40/50/63GM90L holder needs a **right** cassette.

Style	Cat. No.	R	L	DCSFMS (mm)	WF (mm)	LF (mm)	Cap Screw	Tightening Torque (N·m)	Spanner
Straight	PSC40GM00 R/L	●	●	40	22	80*	BFTX0619N	7,5	LT25
	PSC50GM00 R/L	●	●	50	27				
	PSC63GM00 R/L	●	●	63	33				
L-Style	PSC40GM90 R/L	●	●	40	42*	52,5			
	PSC50GM90 R/L	●	●	50	47*	55,0			
	PSC63GM90 R/L	●	●	63	54*	57,0			

\* Dimension when using radial grooving cassettes.

## Identification Details - Polygon-Toolholder

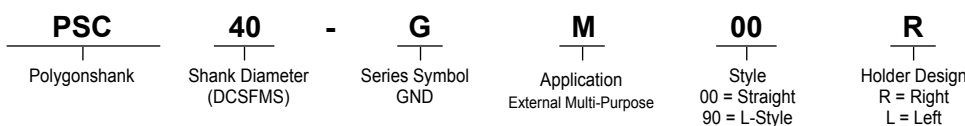

## Identification Details - Cassette

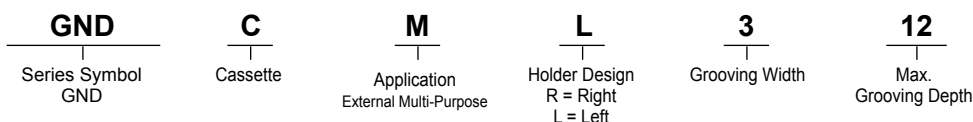



# ISO-PSC Polygon Modular GND Grooving System

## Inserts for GNDCM

Coated Carbide    Cermet    Carbide

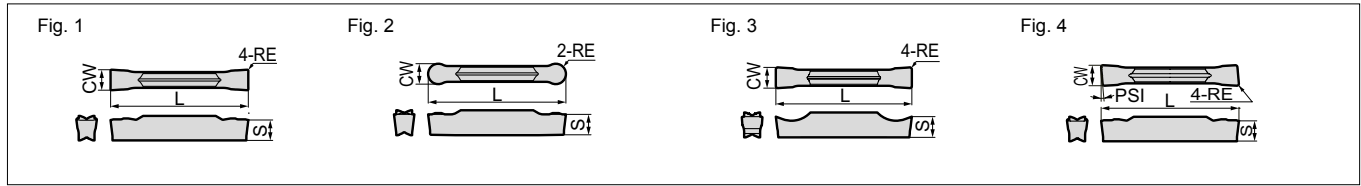

### Grooving / Traversing

Dimensions (mm)

Cat. No.	AC8025P	AC8035P	AC830P	AC425K	AC5015S	AC5025S	AC520U	AC530U	T2500A	CW		RE	L	S	Fig.
										Cutting Width	Tolerance				
GCM N3002 MG	●	●	●	○	●	●	●	●	—	3,0	±0,03	0,2	21,1	3,8	1
N3004 MG	●	●	●	○	●	●	●	●	—	±0,03	0,4	21,1	3,8		
N4002 MG	●	●	●	○	●	●	●	●	—	±0,03	0,2	26,4	4,0		
N4004 MG	●	●	●	○	●	●	●	●	—	4,0	±0,03	0,4	26,4	4,0	
N4008 MG	●	●	●	○	●	●	●	●	—	±0,03	0,8	26,4	4,0		
N5004 MG	●	●	●	○	●	●	●	●	—	5,0	±0,03	0,4	26,4	4,1	
N5008 MG	●	●	●	○	●	●	●	●	—	±0,03	0,8	26,4	4,1		
N6004 MG	●	●	●	○	●	●	●	●	—	6,0	±0,03	0,4	26,4	4,5	
N6008 MG	●	●	●	○	●	●	●	●	—	±0,03	0,8	26,4	4,5		
GCM N2002 ML	—	—	—	—	●	●	●	●	—	2,0	±0,03	0,2	21,1	3,6	1
N3002 ML	●	●	●	○	●	●	●	●	—	3,0	±0,03	0,2	21,1	3,8	
N3004 ML	●	●	●	○	●	●	●	●	—	±0,03	0,4	21,1	3,8		
N4002 ML	●	●	●	○	●	●	●	●	—	±0,03	0,2	26,4	4,0		
N4004 ML	●	●	●	○	●	●	●	●	—	4,0	±0,03	0,4	26,4	4,0	
N4008 ML	●	●	●	○	●	●	●	●	—	±0,03	0,8	26,4	4,0		
N5004 ML	●	●	●	○	●	●	●	●	—	5,0	±0,03	0,4	26,4	4,1	
N5008 ML	●	●	●	○	●	●	●	●	—	±0,03	0,8	26,4	4,1		
N6004 ML	●	●	●	○	●	●	●	●	—	6,0	±0,03	0,4	26,4	4,5	
N6008 ML	●	●	●	○	●	●	●	●	—	±0,03	0,8	26,4	4,5		

### Grooving / Cut-Off Machining

Dimensions (mm)

Cat. No.	AC8035P	AC830P	AC5015S	AC5025S	AC520U	AC530U	T2500A	CW		RE	L	S	Fig.
								Cutting Width	Tolerance				
GCM N2002 GG	●	●	●	●	●	●	—	2,0	±0,03	0,2	21,1	3,6	1
N3002 GG	●	●	●	●	●	●	—	3,0	±0,03	0,2	21,1	3,8	
N3004 GG	●	●	●	○	●	●	—	±0,03	0,4	21,1	3,8		
N4002 GG	●	●	●	○	●	●	—	4,0	±0,03	0,2	26,4	4,0	
N4004 GG	●	●	●	○	●	●	—	±0,03	0,4	26,4	4,0		
N5002 GG	●	●	●	○	●	●	—	5,0	±0,03	0,2	26,4	4,1	
N5004 GG	●	●	●	○	●	●	—	±0,03	0,4	26,4	4,1		
N6002 GG	●	●	●	○	●	●	—	6,0	±0,03	0,2	26,4	4,5	
N6004 GG	●	●	●	○	●	●	—	±0,03	0,4	26,4	4,5		
GCM N2002 GL	●	●	●	○	●	●	—	2,0	±0,03	0,2	21,1	3,6	1
N2004 GL	●	●	●	○	●	●	—	±0,03	0,4	21,1	3,6		
N3002 GL	●	●	●	○	●	●	—	3,0	±0,03	0,2	21,1	3,8	
N3004 GL	●	●	●	○	●	●	—	±0,03	0,4	21,1	3,8		
N4002 GL	●	●	●	○	●	●	—	4,0	±0,03	0,2	26,4	4,0	
N4004 GL	●	●	●	○	●	●	—	±0,03	0,4	26,4	4,0		
N5002 GL	●	●	●	○	●	●	—	5,0	±0,03	0,2	26,4	4,1	
N5004 GL	●	●	●	○	●	●	—	±0,03	0,4	26,4	4,1		
N6002 GL	●	●	●	○	●	●	—	6,0	±0,03	0,2	26,4	4,5	
N6004 GL	●	●	●	○	●	●	—	±0,03	0,4	26,4	4,5		
GCM N2002 GF	—	—	●	●	●	●	○	2,0	±0,03	0,2	21,1	3,6	1
N2004 GF	—	—	●	●	●	●	○	±0,03	0,4	21,1	3,6		
N3002 GF	●	●	●	●	●	●	○	3,0	±0,03	0,2	21,1	3,8	
N3004 GF	●	●	●	●	●	●	○	±0,03	0,4	21,1	3,8		
N4002 GF	●	●	●	●	●	●	○	4,0	±0,03	0,2	26,4	4,0	
N4004 GF	●	●	●	●	●	●	○	±0,03	0,4	26,4	4,0		
N5002 GF	●	●	●	●	●	●	○	5,0	±0,03	0,2	26,4	4,1	
N5004 GF	●	●	●	●	●	●	○	±0,03	0,4	26,4	4,1		
N6002 GF	●	●	●	●	●	●	○	6,0	±0,03	0,2	26,4	4,5	
N6004 GF	●	●	●	●	●	●	○	±0,03	0,4	26,4	4,5		

### External Profiling / External Radius Grooving

Dimensions (mm)

Cat. No.	AC8025P	AC8035P	AC830P	AC425K	AC5015S	AC5025S	AC520U	AC530U	T2500A	CW		RE	L	S	Fig.
										Cutting Width	Tolerance				
GCM N3015 RG	●	●	●	●	●	●	○	●	○	3,0	±0,03	1,5	21,1	3,8	2
N4020 RG	●	●	●	●	●	●	○	●	○	4,0	±0,03	2,0	26,4	4,0	
N5025 RG	●	●	●	●	●	●	○	●	○	5,0	±0,03	2,5	27,2	4,1	
N6030 RG	●	●	●	●	●	●	○	●	○	6,0	±0,03	3,0	27,5	4,5	

### Cut-Off Machining (Handed Edge)

Dimensions (mm)

Cat. No.	AC8035P	AC830P	AC5015S	AC5025S	AC520U	AC530U	AC1030U	CW		RE	L	S	Fig.	
								Cutting Width	Tolerance					
GCM R2002 CG 05	●	●	●	○	●	●	—	5°	2,0	±0,03	0,2	21,1	3,6	4
L2002 CG 05	●	●	●	○	●	●	—	5°	2,0	±0,03	0,2	21,1	3,6	
GCM R3002 CG 05	●	●	●	○	●	●	—	5°	3,0	±0,03	0,2	21,3	3,8	
L3002 CG 05	●	●	●	○	●	●	—	5°	3,0	±0,03	0,2	21,3	3,8	
GCM R4002 CG 05	●	●	●	○	●	●	—	5°	4,0	±0,04	0,2	26,7	4,0	
L4002 CG 05	●	●	●	○	●	●	—	5°	4,0	±0,04	0,2	26,7	4,0	
GCM R2003 CF 10	—	—	●	●	—	—	●	10°	2,0	±0,08	0,03	22,4	3,6	
L2003 CF 10	—	—	●	●	—	—	●	10°	2,0	±0,08	0,03	22,4	3,6	
GCM R3003 CF 10	—	—	●	●	—	—	●	10°	3,0	±0,08	0,03	22,4	3,8	
L3003 CF 10	—	—	●	●	—	—	●	10°	3,0	±0,08	0,03	22,4	3,8	
GCM R2003 CF 15	—	—	●	●	—	—	●	15°	2,0	±0,08	0,03	22,4	3,6	4
L2003 CF 15	—	—	●	●	—	—	●	15°	2,0	±0,08	0,03	22,4	3,6	
GCM R3003 CF 15	—	—	●	●	—	—	●	15°	3,0	±0,08	0,03	22,4	3,8	
L3003 CF 15	—	—	●	●	—	—	●	15°	3,0	±0,08	0,03	22,4	3,8	

GCM R: Right hand    GCM L: Left hand  
Combine the insert with a holder such that the width of cut (CW) matches.

### Profiling / Radius Grooving / Necking

Dimensions (mm)

Cat. No.	AC8025P	AC8035P	AC830P	AC425K	AC5015S	AC5025S	AC520U	AC530U	T2500A	CW		RE	L	S	Fig.
										Cutting Width	Tolerance				
GCM N2010 RN	—	—	—	—	●	●	○	●	—	2,0	±0,03	1,0	21,7	3,6	2
N3015 RN	●	●	●	○	●	●	○	●	—	3,0	±0,03	1,5	22,6	3,8	
N4020 RN	●	●	●	○	●	●	○	●	—	4,0	±0,03	2,0	28,2	4,0	
N5025 RN	●	●	●	○	●	●	○	●	—	5,0	±0,03	2,5	28,3	4,1	
N6030 RN	●	●	●	○	●	●	○	●	—	6,0	±0,03	3,0	28,3	4,5	

### Non-Ferrous Metals

Dimensions (mm)

Cat. No.	H1	CW		RE	L	S	Fig.
		Cutting Width	Tolerance				
GCG N2002 GA	○	2,0	±0,025	0,2	21,1	3,6	3
N3002 GA	○	3,0	±0,025	0,2	21,1	3,8	
N4004 GA	○	4,0	±0,025	0,4	26,4	4,0	
N5004 GA	○	5,0	±0,025	0,4	26,4	4,1	
N6004 GA	○	6,0	±0,025	0,4	26,4	4,5	



# ISO-PSC Polygon Modular GND Grooving System

Cassette with Internal Coolant

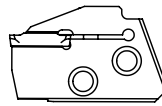
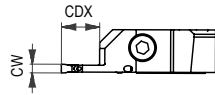
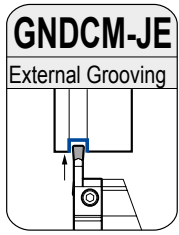

## General Features

The already established GND grooving system with polygon shank and a flexible cassette system for grooving inserts, has been extended by a version with internal coolant supply. The direct cooling at the cutting edge ensures excellent chip breaking and improves chip control during external grooving.

## Advantages

- External grooving cassettes with internal coolant supply
- PSC Polygon holders straight and 90° with internal coolant supply
- GND inserts for soft grooving from 2,0-6,0 mm grooving width
- Provides excellent chip control
- Depending on the coolant pressure, the tool life of the cutting edge will increase significantly.

## Cassette with Internal Coolant

Cat. No.	R	L	CW (mm)	CDX (mm)	Inserts	Cap Screw	Tightening Torque (N·m)	Spanner
GNDCM R/L 212-JE	●	●	2	12	GCM □20□□-□□	BX0512	5,0 <sup>(Nm)</sup>	LH040
GNDCM R/L 312-JE	●	●	3		GCM □30□□-□□			
GNDCM R/L 418-JE	●	●	4	GCM □40□□-□□	6,0 <sup>(Nm)</sup>			
GNDCM R/L 518-JE	●	●	5	GCM □50□□-□□				
GNDCM R/L 618-JE	●	●	6	GCM □60□□-□□				

## Handling

### ATTENTION

To fix the cassette on the holder, please clamp the cassette at first with the inner torx screw.

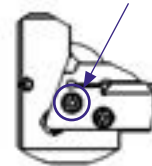

## Holder

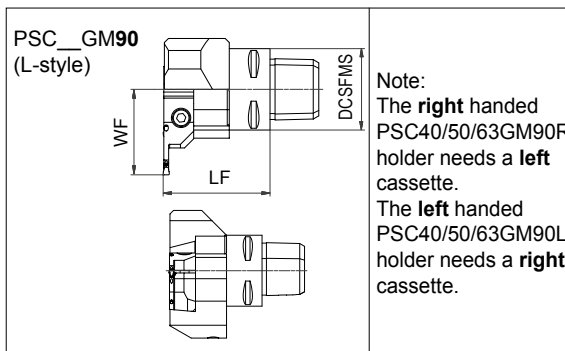
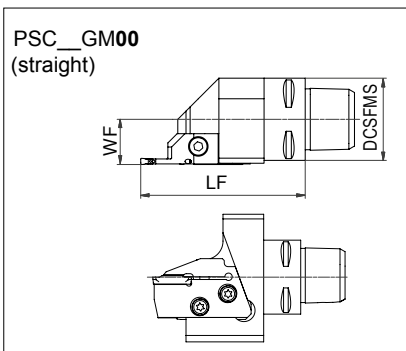

Note:  
The right handed PSC40/50/63GM90R holder needs a left cassette.  
The left handed PSC40/50/63GM90L holder needs a right cassette.

Style	Cat. No.	R	L	DCSFMS (mm)	WF (mm)	LF (mm)	Cap Screw	Tightening Torque (N·m)	Spanner	Sealing Set (4xOring)
Straight	PSC40GM00 R/L-JE	●	●	40	22	80*	BFTX0619N	7,5 <sup>(Nm)</sup>	LT25	ARC SET
	PSC50GM00 R/L-JE	●	●	50	27					
	PSC63GM00 R/L-JE	●	●	63	33					
L-Style	PSC40GM90 R/L-JE	●	●	40	42*	52,5				
	PSC50GM90 R/L-JE	●	●	50	47*	55,0				
	PSC63GM90 R/L-JE	●	●	63	54*	57,0				

\* Dimension when using radial grooving cassettes.

## Identification Details - Polygon-Toolholder

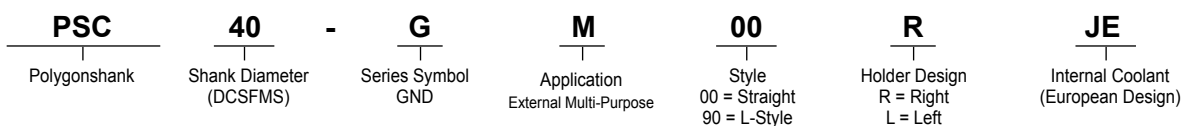

## Identification Details - Cassette

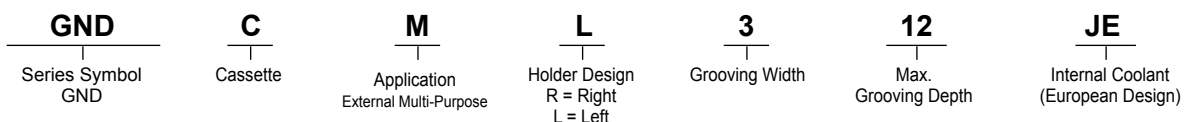

● Euro stock



# ISO-PSC Polygon Modular GND Grooving System

## Inserts for GNDCM-JE

Coated Carbide    Cermet    Carbide

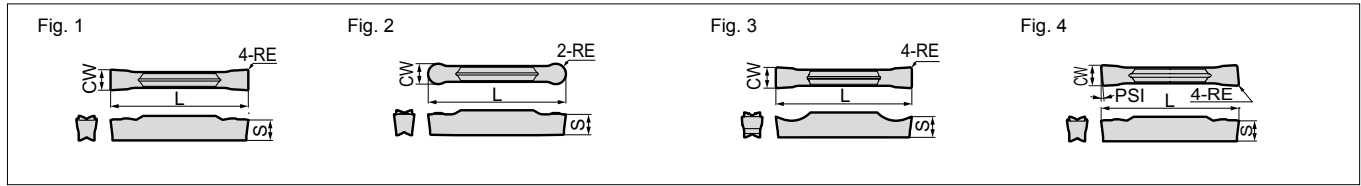

### Grooving / Traversing

Dimensions (mm)

Cat. No.	AC8025P	AC8035P	AC830P	AC425K	AC5015S	AC5025S	AC520U	AC530U	T2500A	CW		RE	L	S	Fig.
										Cutting Width	Tolerance				
GCM N3002 MG	●	●	●	○	●	●	○	●	—	3,0	±0,03	0,2	21,1	3,8	1
N3004 MG	●	●	●	○	●	●	○	●	—	±0,03	0,4	21,1	3,8		
N4002 MG	●	●	●	○	●	●	○	●	—	±0,03	0,2	26,4	4,0		
N4004 MG	●	●	●	○	●	●	○	●	—	4,0	±0,03	0,4	26,4	4,0	
N4008 MG	●	●	●	○	●	●	○	●	—	±0,03	0,8	26,4	4,0		
N5004 MG	●	●	●	○	●	●	○	●	—	5,0	±0,03	0,4	26,4	4,1	
N5008 MG	●	●	●	○	●	●	○	●	—	±0,03	0,8	26,4	4,1		
N6004 MG	●	●	●	○	●	●	○	●	—	6,0	±0,03	0,4	26,4	4,5	
N6008 MG	●	●	●	○	●	●	○	●	—	±0,03	0,8	26,4	4,5		
GCM N2002 ML	—	—	—	—	●	●	○	●	—	2,0	±0,03	0,2	21,1	3,6	1
N3002 ML	●	●	●	○	●	●	○	●	—	3,0	±0,03	0,2	21,1	3,8	
N3004 ML	●	●	●	○	●	●	○	●	—	±0,03	0,4	21,1	3,8		
N4002 ML	●	●	●	○	●	●	○	●	—	±0,03	0,2	26,4	4,0		
N4004 ML	●	●	●	○	●	●	○	●	—	4,0	±0,03	0,4	26,4	4,0	
N4008 ML	●	●	●	○	●	●	○	●	—	±0,03	0,8	26,4	4,0		
N5004 ML	●	●	●	○	●	●	○	●	—	5,0	±0,03	0,4	26,4	4,1	
N5008 ML	●	●	●	○	●	●	○	●	—	±0,03	0,8	26,4	4,1		
N6004 ML	●	●	●	○	●	●	○	●	—	6,0	±0,03	0,4	26,4	4,5	
N6008 ML	●	●	●	○	●	●	○	●	—	±0,03	0,8	26,4	4,5		

### Grooving / Cut-Off Machining

Dimensions (mm)

Cat. No.	AC8035P	AC830P	AC5015S	AC5025S	AC520U	AC530U	T2500A	CW		RE	L	S	Fig.
								Cutting Width	Tolerance				
GCM N2002 GG	●	●	●	●	○	●	—	2,0	±0,03	0,2	21,1	3,6	1
N3002 GG	●	●	●	○	●	●	—	3,0	±0,03	0,2	21,1	3,8	
N3004 GG	●	●	●	○	●	●	—	±0,03	0,4	21,1	3,8		
N4002 GG	●	●	●	○	●	●	—	4,0	±0,03	0,2	26,4	4,0	
N4004 GG	●	●	●	○	●	●	—	±0,03	0,4	26,4	4,0		
N5002 GG	●	●	●	○	●	●	—	5,0	±0,03	0,2	26,4	4,1	
N5004 GG	●	●	●	○	●	●	—	±0,03	0,4	26,4	4,1		
N6002 GG	●	●	●	○	●	●	—	6,0	±0,03	0,2	26,4	4,5	
N6004 GG	●	●	●	○	●	●	—	±0,03	0,4	26,4	4,5		
GCM N2002 GL	●	●	●	○	●	●	—	2,0	±0,03	0,2	21,1	3,6	1
N2004 GL	●	●	●	○	●	●	—	±0,03	0,4	21,1	3,6		
N3002 GL	●	●	●	○	●	●	—	3,0	±0,03	0,2	21,1	3,8	
N3004 GL	●	●	●	○	●	●	—	±0,03	0,4	21,1	3,8		
N4002 GL	●	●	●	○	●	●	—	4,0	±0,03	0,2	26,4	4,0	
N4004 GL	●	●	●	○	●	●	—	±0,03	0,4	26,4	4,0		
N5002 GL	●	●	●	○	●	●	—	5,0	±0,03	0,2	26,4	4,1	
N5004 GL	●	●	●	○	●	●	—	±0,03	0,4	26,4	4,1		
N6002 GL	●	●	●	○	●	●	—	6,0	±0,03	0,2	26,4	4,5	
N6004 GL	●	●	●	○	●	●	—	±0,03	0,4	26,4	4,5		
GCM N2002 GF	—	—	●	●	○	●	—	2,0	±0,03	0,2	21,1	3,6	1
N2004 GF	—	—	●	●	○	●	—	±0,03	0,4	21,1	3,6		
N3002 GF	●	●	●	○	●	●	—	3,0	±0,03	0,2	21,1	3,8	
N3004 GF	●	●	●	○	●	●	—	±0,03	0,4	21,1	3,8		
N4002 GF	●	●	●	○	●	●	—	4,0	±0,03	0,2	26,4	4,0	
N4004 GF	●	●	●	○	●	●	—	±0,03	0,4	26,4	4,0		
N5002 GF	●	●	●	○	●	●	—	5,0	±0,03	0,2	26,4	4,1	
N5004 GF	●	●	●	○	●	●	—	±0,03	0,4	26,4	4,1		
N6002 GF	●	●	●	○	●	●	—	6,0	±0,03	0,2	26,4	4,5	
N6004 GF	●	●	●	○	●	●	—	±0,03	0,4	26,4	4,5		

### External Profiling / External Radius Grooving

Dimensions (mm)

Cat. No.	AC8025P	AC8035P	AC830P	AC425K	AC5015S	AC5025S	AC520U	AC530U	T2500A	CW		RE	L	S	Fig.
										Cutting Width	Tolerance				
GCM N3015 RG	●	●	●	○	●	●	○	●	—	3,0	±0,03	1,5	21,1	3,8	2
N4020 RG	●	●	●	○	●	●	○	●	—	4,0	±0,03	2,0	26,4	4,0	
N5025 RG	●	●	●	○	●	●	○	●	—	5,0	±0,03	2,5	27,2	4,1	
N6030 RG	●	●	●	○	●	●	○	●	—	6,0	±0,03	3,0	27,5	4,5	

### Cut-Off Machining (Handed Edge)

Dimensions (mm)

Cat. No.	AC8035P	AC830P	AC5015S	AC5025S	AC520U	AC530U	AC1030U	CW		RE	L	S	Fig.	
								Cutting Width	Tolerance					
GCM R2002 CG 05	●	●	●	○	●	●	—	5°	2,0	±0,03	0,2	21,1	3,6	4
L2002 CG 05	●	●	●	○	●	●	—	5°	2,0	±0,03	0,2	21,1	3,6	
GCM R3002 CG 05	●	●	●	○	●	●	—	5°	3,0	±0,03	0,2	21,3	3,8	
L3002 CG 05	●	●	●	○	●	●	—	5°	3,0	±0,03	0,2	21,3	3,8	
GCM R4002 CG 05	●	●	●	○	●	●	—	5°	4,0	±0,04	0,2	26,7	4,0	
L4002 CG 05	●	●	●	○	●	●	—	5°	4,0	±0,04	0,2	26,7	4,0	
GCM R2003 CF 10	—	—	●	●	—	—	●	10°	2,0	±0,08	0,03	22,4	3,6	
L2003 CF 10	—	—	●	●	—	—	●	10°	2,0	±0,08	0,03	22,4	3,6	
GCM R3003 CF 10	—	—	●	●	—	—	●	10°	3,0	±0,08	0,03	22,4	3,8	
L3003 CF 10	—	—	●	●	—	—	●	10°	3,0	±0,08	0,03	22,4	3,8	
GCM R2003 CF 15	—	—	●	●	—	—	●	15°	2,0	±0,08	0,03	22,4	3,6	4
L2003 CF 15	—	—	●	●	—	—	●	15°	2,0	±0,08	0,03	22,4	3,6	
GCM R3003 CF 15	—	—	●	●	—	—	●	15°	3,0	±0,08	0,03	22,4	3,8	
L3003 CF 15	—	—	●	●	—	—	●	15°	3,0	±0,08	0,03	22,4	3,8	

GCM R: Right hand    GCM L: Left hand  
Combine the insert with a holder such that the width of cut (CW) matches.

### Profiling / Radius Grooving / Necking

Dimensions (mm)

Cat. No.	AC8025P	AC8035P	AC830P	AC425K	AC5015S	AC5025S	AC520U	AC530U	T2500A	CW		RE	L	S	Fig.
										Cutting Width	Tolerance				
GCM N2010 RN	—	—	—	—	●	●	○	●	—	2,0	±0,03	1,0	21,7	3,6	2
N3015 RN	●	●	●	○	●	●	○	●	—	3,0	±0,03	1,5	22,6	3,8	
N4020 RN	●	●	●	○	●	●	○	●	—	4,0	±0,03	2,0	28,2	4,0	
N5025 RN	●	●	●	○	●	●	○	●	—	5,0	±0,03	2,5	28,3	4,1	
N6030 RN	●	●	●	○	●	●	○	●	—	6,0	±0,03	3,0	28,3	4,5	

### Non-Ferrous Metals

Dimensions (mm)

Cat. No.	H1	CW		RE	L	S	Fig.
		Cutting Width	Tolerance				
GCG N2002 GA	○	2,0	±0,025	0,2	21,1	3,6	3
N3002 GA	○	3,0	±0,025	0,2	21,1	3,8	
N4004 GA	○	4,0	±0,025	0,4	26,4	4,0	
N5004 GA	○	5,0	±0,025	0,4	26,4	4,1	
N6004 GA	○	6,0	±0,025	0,4	26,4	4,5	

# ISO-PSC Polygon Modular GND Grooving System

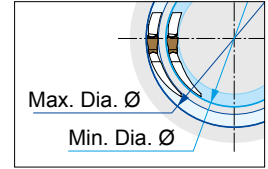
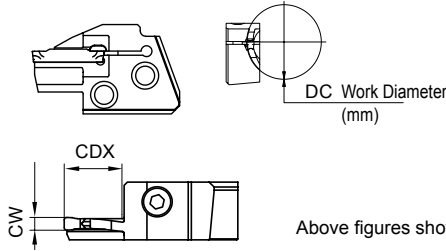
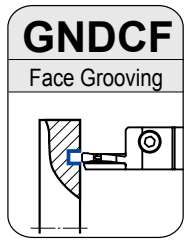

Work diameters in the stock indicate external diameters of face grooving.

Above figures show right hand tools.

## Cassette

Cat. No.	R	L	CW (mm)	Diameter Range (mm)	DC (mm)	CDX (mm)	Inserts	Cap Screw	Tightening Torque (N-m)	Spanner
GNDCF R/L 312-040	●	●	3	40-200	40-55	12	GC □ N3000-□□	BX0512	5,0	LH040
GNDCF R/L 315-050	●	●			50-70	15				
GNDCF R/L 315-065	●	●			65-100	15				
GNDCF R/L 318-090	●	□			90-150	18				
GNDCF R/L 318-140	●	□			140-200	18				
GNDCF R/L 418-040	●	●	4	40-300	40-55	18	GC □ N4000-□□		6,0	
GNDCF R/L 418-050	●	□			50-70	18				
GNDCF R/L 418-065	●	●			65-90	18				
GNDCF R/L 418-085	●	□			85-130	18				
GNDCF R/L 418-125	□	□			125-200	18				
GNDCF R/L 418-180	●	□	180-300	18						
GNDCF R/L 518-050	□	□	5	50-300	50-70	18	GC □ N5000-□□	6,0		
GNDCF R/L 518-065	□	□			65-90	18				
GNDCF R/L 518-085	□	□			85-130	18				
GNDCF R/L 518-125	●	□			125-200	18				
GNDCF R/L 518-180	□	□			180-300	18				
GNDCF R/L 618-050	□	□	6	50-1000	50-75	18	GC □ N6000-□□		6,0	
GNDCF R/L 618-070	□	□			70-110	18				
GNDCF R/L 618-100	□	□			100-200	18				
GNDCF R/L 618-180	□	□			180-300	18				
GNDCF R/L 618-280	□	□			280-1000	18				

## Holder

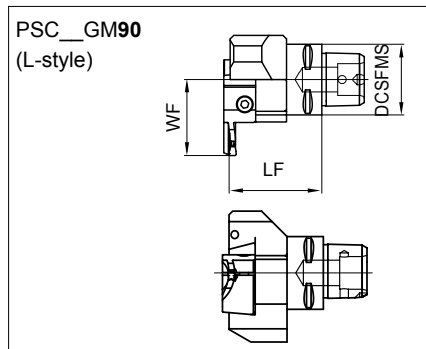
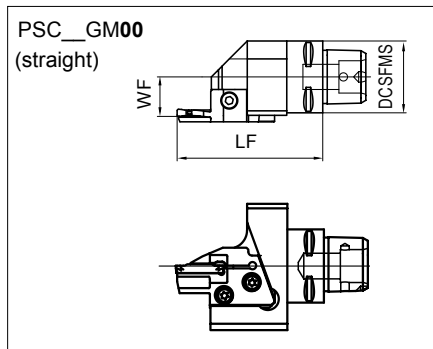

Note:  
The **right** handed PSC40/50/63GM90R holder needs a **left** cassette.  
The **left** handed PSC40/50/63GM90L holder needs a **right** cassette.

Style	Cat. No.	R	L	DCSFMS (mm)	WF (mm)	LF (mm)	Cap Screw	Tightening Torque (N-m)	Spanner
Straight	PSC40GM00 R/L	●	●	40	22	80*	BFTX0619N	7,5	LT25
	PSC50GM00 R/L	●	●	50	27				
	PSC63GM00 R/L	●	●	63	33				
L-Style	PSC40GM90 R/L	●	●	40	42*	52,5			
	PSC50GM90 R/L	●	●	50	47*	55,0			
	PSC63GM90 R/L	●	●	63	54*	57,0			

\* Dimension when using face grooving cassettes.

## Identification Details - Polygon-Toolholder

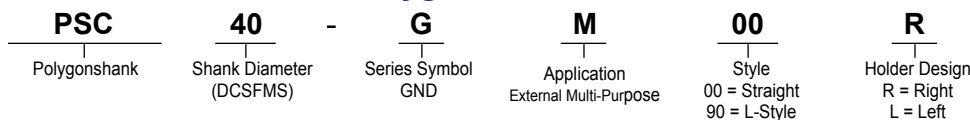

## Identification Details - Cassette

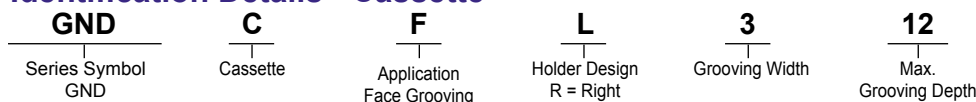

● Euro stock    □ = On request



# ISO-PSC Polygon Modular GND Grooving System

## Inserts for GNDCF

Coated Carbide    
  Cermet    
  Carbide

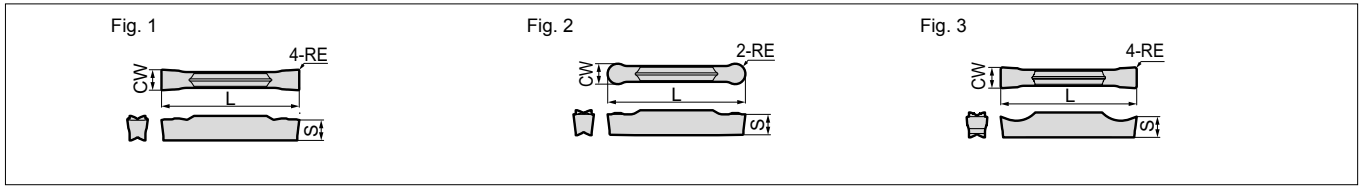

### Grooving / Traversing

Dimensions (mm)

Cat. No.	AC8025P	AC8035P	AC830P	AC425K	AC5015S	AC5025S	AC520U	AC530U	T2500A	CW		RE	L	S	Fig.
										Cutting Width	Tolerance				
GCM N3002 MG	●	●	●	○	●	●	●	●	—	3,0	±0,03	0,2	21,1	3,8	1
N3004 MG	●	●	●	○	●	●	●	●	—	±0,03	0,4	21,1	3,8		
N4002 MG	●	●	●	○	●	●	●	●	—	±0,03	0,2	26,4	4,0		
N4004 MG	●	●	●	○	●	●	●	●	—	4,0	±0,03	0,4	26,4	4,0	
N4008 MG	●	●	●	○	●	●	●	●	—	±0,03	0,8	26,4	4,0		
N5004 MG	●	●	●	○	●	●	●	●	—	5,0	±0,03	0,4	26,4	4,1	
N5008 MG	●	●	●	○	●	●	●	●	—	±0,03	0,8	26,4	4,1		
N6004 MG	●	●	●	○	●	●	●	●	—	6,0	±0,03	0,4	26,4	4,5	
N6008 MG	●	●	●	○	●	●	●	●	—	±0,03	0,8	26,4	4,5		
GCM N3002 ML	●	●	●	○	●	●	●	●	○	3,0	±0,03	0,2	21,1	3,8	1
N3004 ML	●	●	●	○	●	●	●	●	○	±0,03	0,4	21,1	3,8		
N4002 ML	●	●	●	○	●	●	●	●	○	±0,03	0,2	26,4	4,0		
N4004 ML	●	●	●	○	●	●	●	●	○	4,0	±0,03	0,4	26,4	4,0	
N4008 ML	●	●	●	○	●	●	●	●	○	±0,03	0,8	26,4	4,0		
N5004 ML	●	●	●	○	●	●	●	●	○	±0,03	0,4	26,4	4,1		
N5008 ML	●	●	●	○	●	●	●	●	○	±0,03	0,8	26,4	4,1		
N6004 ML	●	●	●	○	●	●	●	●	○	±0,03	0,4	26,4	4,5		
N6008 ML	●	●	●	○	●	●	●	●	○	±0,03	0,8	26,4	4,5		

### Grooving / Cut-Off Machining

Dimensions (mm)

Cat. No.	AC8035P	AC830P	AC5015S	AC5025S	AC520U	AC530U	T2500A	CW		RE	L	S	Fig.
								Cutting Width	Tolerance				
GCM N3002 GG	●	●	●	●	●	●	—	3,0	±0,03	0,2	21,1	3,8	1
N3004 GG	●	●	●	●	●	●	—	±0,03	0,4	21,1	3,8		
N4002 GG	●	●	●	○	●	●	—	4,0	±0,03	0,2	26,4	4,0	
N4004 GG	●	●	●	○	●	●	—	±0,03	0,4	26,4	4,0		
N5002 GG	●	●	●	○	●	●	—	5,0	±0,03	0,2	26,4	4,1	
N5004 GG	●	●	●	○	●	●	—	±0,03	0,4	26,4	4,1		
N6002 GG	●	●	●	○	●	●	—	6,0	±0,03	0,2	26,4	4,5	
N6004 GG	●	●	●	○	●	●	—	±0,03	0,4	26,4	4,5		
GCM N3002 GL	●	●	●	○	●	●	—	3,0	±0,03	0,2	21,1	3,8	1
N3004 GL	●	●	●	○	●	●	—	±0,03	0,4	21,1	3,8		
N4002 GL	●	●	●	○	●	●	—	4,0	±0,03	0,2	26,4	4,0	
N4004 GL	●	●	●	○	●	●	—	±0,03	0,4	26,4	4,0		
N5002 GL	●	●	●	○	●	●	—	5,0	±0,03	0,2	26,4	4,1	
N5004 GL	●	●	●	○	●	●	—	±0,03	0,4	26,4	4,1		
N6002 GL	●	●	●	○	●	●	—	6,0	±0,03	0,2	26,4	4,5	
N6004 GL	●	●	●	○	●	●	—	±0,03	0,4	26,4	4,5		
GCM N3002 GF	●	●	●	○	●	●	—	3,0	±0,03	0,2	21,1	3,8	1
N3004 GF	●	●	●	○	●	●	—	±0,03	0,4	21,1	3,8		
N4002 GF	●	●	●	○	●	●	—	4,0	±0,03	0,2	26,4	4,0	
N4004 GF	●	●	●	○	●	●	—	±0,03	0,4	26,4	4,0		
N5002 GF	●	●	●	○	●	●	—	5,0	±0,03	0,2	26,4	4,1	
N5004 GF	●	●	●	○	●	●	—	±0,03	0,4	26,4	4,1		
N6002 GF	●	●	●	○	●	●	—	6,0	±0,03	0,2	26,4	4,5	
N6004 GF	●	●	●	○	●	●	—	±0,03	0,4	26,4	4,5		

Combine the insert with a holder such that the width of cut (CW) matches.

### Profiling / Radius Grooving / Necking

Dimensions (mm)

Cat. No.	AC8025P	AC8035P	AC830P	AC425K	AC5015S	AC5025S	AC520U	AC530U	T2500A	CW		RE	L	S	Fig.
										Cutting Width	Tolerance				
GCM N3015 RN	●	●	●	○	●	●	●	●	—	3,0	±0,03	1,5	22,6	3,8	2
N4020 RN	●	●	●	○	●	●	●	●	—	4,0	±0,03	2,0	28,2	4,0	
N5025 RN	●	●	●	○	●	●	●	●	—	5,0	±0,03	2,5	28,3	4,1	
N6030 RN	●	●	●	○	●	●	●	●	—	6,0	±0,03	3,0	28,3	4,5	

### Non-Ferrous Metals

Dimensions (mm)

Cat. No.	H1									CW		RE	L	S	Fig.
		Cutting Width	Tolerance												
GCM N3002 GA	○									3,0	±0,025	0,2	21,1	3,8	3
N4004 GA	○									4,0	±0,025	0,4	26,4	4,0	
N5004 GA	○									5,0	±0,025	0,4	26,4	4,1	
N6004 GA	○									6,0	±0,025	0,4	26,4	4,5	

# ISO-PSC Polygon Modular GND Grooving System

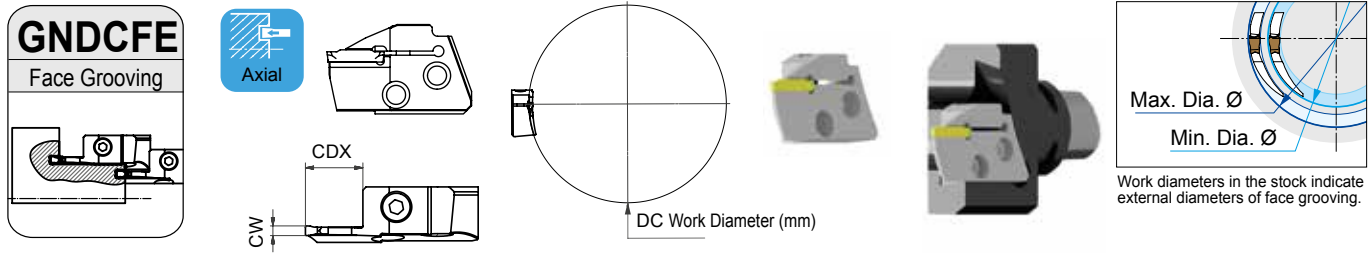

Above figures show right hand tools.

## Cassette

Cat. No.	R	L	CW (mm)	Diameter Range (mm)	DC (mm)	CDX (mm)	Inserts	Cap Screw	Tightening Torque (N·m)	Spanner		
GNDCFE R/L 312-040	●	●	3	40-200	40-55	12	GC □ N3000-□□	BX0512	5,0	LH040		
GNDCFE R/L 315-050	●	●			50-70	15						
GNDCFE R/L 317-065	●	●			65-100	15						
GNDCFE R/L 317-090	●	●			90-150	17						
GNDCFE R/L 317-140	●	●			140-200	17						
GNDCFE R/L 417-040	●	●	4	40-300	40-55	17	GC □ N4000-□□		BX0512		6,0	LH040
GNDCFE R/L 417-050	●	●			50-70	17						
GNDCFE R/L 417-065	●	●			65-90	17						
GNDCFE R/L 417-085	●	●			85-130	17						
GNDCFE R/L 417-125	●	●			125-200	17						
GNDCFE R/L 417-180	●	●	180-300	17								
GNDCFE R/L 517-050	□	□	5	50-300	50-70	17	GC □ N5000-□□	BX0512		6,0	LH040	
GNDCFE R/L 517-065	□	□			65-90	17						
GNDCFE R/L 517-085	□	□			85-130	17						
GNDCFE R/L 517-125	□	□			125-200	17						
GNDCFE R/L 517-180	□	□			180-300	17						
GNDCFE R/L 617-050	□	□	6	50-1000	50-75	17	GC □ N6000-□□		BX0512	6,0		LH040
GNDCFE R/L 617-070	□	□			70-110	17						
GNDCFE R/L 617-100	□	□			100-200	17						
GNDCFE R/L 617-180	□	□			180-300	17						
GNDCFE R/L 617-280	□	□			280-1000	17						

## Holder

**PSC\_GM00**  
(straight)

**PSC\_GM90**  
(L-style)

**Note:**  
The **right** handed PSC40/50/63GM90R holder needs a **left** cassette.  
The **left** handed PSC40/50/63GM90L holder needs a **right** cassette.

Style	Cat. No.	R	L	DCSFMS (mm)	WF (mm)	LF (mm)	Cap Screw	Tightening Torque (N·m)	Spanner			
Straight	PSC40GM00 R/L	●	●	40	22	80*	BFTX0619N	7,5	LT25			
	PSC50GM00 R/L	●	●	50	27							
	PSC63GM00 R/L	●	●	63	33							
L-Style	PSC40GM90 R/L	●	●	40	42*	52,5				BFTX0619N	7,5	LT25
	PSC50GM90 R/L	●	●	50	47*	55,0						
	PSC63GM90 R/L	●	●	63	54*	57,0						

\* Dimension when using face grooving cassettes.

## Identification Details - Polygon-Toolholder

<b>PSC</b>	<b>40</b>	-	<b>G</b>	<b>M</b>	<b>00</b>	<b>R</b>	<b>JE</b>
Polygonshank	Shank Diameter (DCSFMS)		Series Symbol GND	Application External Multi-Purpose	Style 00 = Straight 90 = L-Style	Holder Design R = Right L = Left	Internal Coolant (European Design)

## Identification Details - Cassette

<b>GND</b>	<b>C</b>	<b>F</b>	<b>L</b>	<b>3</b>	<b>12</b>	<b>JE</b>
Series Symbol GND	Cassette	Application Face Grooving	Holder Design R = Right L = Left	Grooving Width	Max. Grooving Depth	Internal Coolant (European Design)

● Euro stock

□ = On request



# ISO-PSC Polygon Modular GND Grooving System

## Inserts for GNDCF

Coated Carbide    
  Cermet    
  Carbide

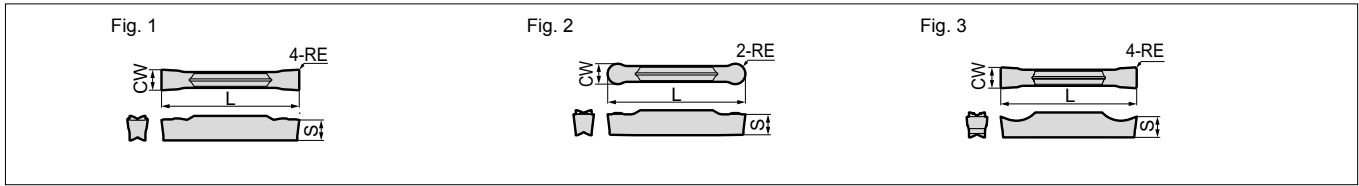

### Grooving / Traversing

Dimensions (mm)

Cat. No.	AC8025P	AC8035P	AC830P	AC425K	AC5015S	AC5025S	AC520U	AC530U	T2500A	CW		RE	L	S	Fig.
										Cutting Width	Tolerance				
GCM N3002 MG	●	●	●	○	●	●	●	●	—	3,0	±0,03	0,2	21,1	3,8	1
N3004 MG	●	●	●	○	●	●	●	●	—	±0,03	0,4	21,1	3,8		
N4002 MG	●	●	●	○	●	●	●	●	—	4,0	±0,03	0,2	26,4	4,0	
N4004 MG	●	●	●	○	●	●	●	●	—	±0,03	0,4	26,4	4,0		
N4008 MG	●	●	●	○	●	●	●	●	—	±0,03	0,8	26,4	4,0		
N5004 MG	●	●	●	○	●	●	●	●	—	5,0	±0,03	0,4	26,4	4,1	
N5008 MG	●	●	●	○	●	●	●	●	—	±0,03	0,8	26,4	4,1		
N6004 MG	●	●	●	○	●	●	●	●	—	6,0	±0,03	0,4	26,4	4,5	
N6008 MG	●	●	●	○	●	●	●	●	—	±0,03	0,8	26,4	4,5		
GCM N3002 ML	●	●	●	○	●	●	●	○	—	3,0	±0,03	0,2	21,1	3,8	1
N3004 ML	●	●	●	○	●	●	●	○	—	±0,03	0,4	21,1	3,8		
N4002 ML	●	●	●	○	●	●	●	○	—	4,0	±0,03	0,2	26,4	4,0	
N4004 ML	●	●	●	○	●	●	●	○	—	±0,03	0,4	26,4	4,0		
N4008 ML	●	●	●	○	●	●	●	○	—	±0,03	0,8	26,4	4,0		
N5004 ML	●	●	●	○	●	●	●	○	—	5,0	±0,03	0,4	26,4	4,1	
N5008 ML	●	●	●	○	●	●	●	○	—	±0,03	0,8	26,4	4,1		
N6004 ML	●	●	●	○	●	●	●	○	—	6,0	±0,03	0,4	26,4	4,5	
N6008 ML	●	●	●	○	●	●	●	○	—	±0,03	0,8	26,4	4,5		

### Grooving / Cut-Off Machining

Dimensions (mm)

Cat. No.	AC8035P	AC830P	AC5015S	AC5025S	AC520U	AC530U	T2500A	CW		RE	L	S	Fig.
								Cutting Width	Tolerance				
GCM N3002 GG	●	●	●	○	●	●	—	3,0	±0,03	0,2	21,1	3,8	1
N3004 GG	●	●	●	○	●	●	—	±0,03	0,4	21,1	3,8		
N4002 GG	●	●	●	○	●	●	—	4,0	±0,03	0,2	26,4	4,0	
N4004 GG	●	●	●	○	●	●	—	±0,03	0,4	26,4	4,0		
N5002 GG	●	●	●	○	●	●	—	5,0	±0,03	0,2	26,4	4,1	
N5004 GG	●	●	●	○	●	●	—	±0,03	0,4	26,4	4,1		
N6002 GG	●	●	●	○	●	●	—	6,0	±0,03	0,2	26,4	4,5	
N6004 GG	●	●	●	○	●	●	—	±0,03	0,4	26,4	4,5		
GCM N3002 GL	●	●	●	○	●	●	—	3,0	±0,03	0,2	21,1	3,8	1
N3004 GL	●	●	●	○	●	●	—	±0,03	0,4	21,1	3,8		
N4002 GL	●	●	●	○	●	●	—	4,0	±0,03	0,2	26,4	4,0	
N4004 GL	●	●	●	○	●	●	—	±0,03	0,4	26,4	4,0		
N5002 GL	●	●	●	○	●	●	—	5,0	±0,03	0,2	26,4	4,1	
N5004 GL	●	●	●	○	●	●	—	±0,03	0,4	26,4	4,1		
N6002 GL	●	●	●	○	●	●	—	6,0	±0,03	0,2	26,4	4,5	
N6004 GL	●	●	●	○	●	●	—	±0,03	0,4	26,4	4,5		
GCM N3002 GF	●	●	●	○	●	●	—	3,0	±0,03	0,2	21,1	3,8	1
N3004 GF	●	●	●	○	●	●	—	±0,03	0,4	21,1	3,8		
N4002 GF	●	●	●	○	●	●	—	4,0	±0,03	0,2	26,4	4,0	
N4004 GF	●	●	●	○	●	●	—	±0,03	0,4	26,4	4,0		
N5002 GF	●	●	●	○	●	●	—	5,0	±0,03	0,2	26,4	4,1	
N5004 GF	●	●	●	○	●	●	—	±0,03	0,4	26,4	4,1		
N6002 GF	●	●	●	○	●	●	—	6,0	±0,03	0,2	26,4	4,5	
N6004 GF	●	●	●	○	●	●	—	±0,03	0,4	26,4	4,5		

Combine the insert with a holder such that the width of cut (CW) matches.

### Profiling / Radius Grooving / Necking

Dimensions (mm)

Cat. No.	AC8025P	AC8035P	AC830P	AC425K	AC5015S	AC5025S	AC520U	AC530U	T2500A	CW		RE	L	S	Fig.
										Cutting Width	Tolerance				
GCM N3015 RN	●	●	●	○	●	●	●	●	—	3,0	±0,03	1,5	22,6	3,8	2
N4020 RN	●	●	●	○	●	●	●	●	—	4,0	±0,03	2,0	28,2	4,0	
N5025 RN	●	●	●	○	●	●	●	●	—	5,0	±0,03	2,5	28,3	4,1	
N6030 RN	●	●	●	○	●	●	●	●	—	6,0	±0,03	3,0	28,3	4,5	

### Non-Ferrous Metals

Dimensions (mm)

Cat. No.	H1									CW		RE	L	S	Fig.
		Cutting Width	Tolerance												
GCM N3002 GA	○									3,0	±0,025	0,2	21,1	3,8	3
N4004 GA	○									4,0	±0,025	0,4	26,4	4,0	
N5004 GA	○									5,0	±0,025	0,4	26,4	4,1	
N6004 GA	○									6,0	±0,025	0,4	26,4	4,5	



# ISO-PSC Polygon Modular GND Grooving System



## Application Examples

### Case-Hardened Steel, Synchronizer Ring, Face Grooving

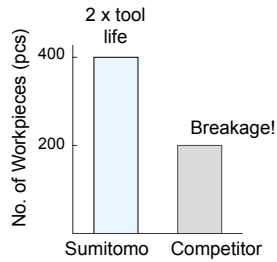
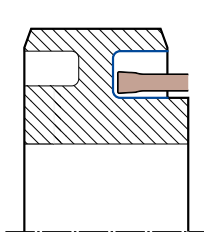

Holder: PSC40GM00R  
Cassette: GNDCFR618-050  
Insert: GCMN6004MLAC830P

Cutting Conditions:  $v_c = 180$  m/min,  $f = 0,15$  mm/rev,  $t_e = 0,16$  min  
Coolant: air

### 21CrNiMo2, Gear, Face Grooving

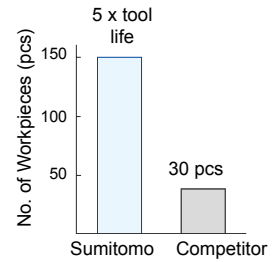
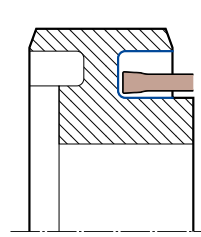

Holder: PSC40GM90L  
Cassette: GNDCFR518-050  
Insert: GCMN5004MLAC830P

Cutting Conditions:  $v_c = 200$  m/min,  $f = 0,154$  mm/rev,  $t_e = 0,73$  min  
Coolant: -



CARBIDE - CBN - DIAMOND

(Germany)  
SUMITOMO ELECTRIC Hartmetall GmbH  
Konrad-Zuse-Straße 9, 47877 Willich

Tel. +49 2154 4992-0, Fax +49 2154 4992-161  
Info@SumitomoTool.com  
www.SumitomoTool.com



(UK and Ireland)  
SUMITOMO ELECTRIC Hardmetal Ltd.  
Summerleys Road, Princes Risborough  
Buckinghamshire HP27 9PW, UK

Tel. +44 1844 342081, Fax: +44 1844 342415  
InfoUK@SumitomoTool.com  
www.SumitomoTool.com



Distributed by: